



Optical DVI Dual Link Extension Module

*User's Manual
for the M1-3R2VI-DU*



Manual Contents

Manual Contents	1-0
Welcome!, Product Description	1-1
System Requirements for Setup	1-2
Installation – Direct DDC	1-3
Installation – Virtual DDC	1-5
Troubleshooting, Maintenance, Technical Support	1-7
Product Specifications	1-8
Warranty Information	1-9
Regulatory Statements	1-10

Pictorials

Figure 1 – Overall Optical DVI Module	1-2
Figure 2 – Connection of DVI cable between Transmitter box and PC	1-3
Figure 3 – Connection of DVI cable between Receiver box and the display	1-3
Figure 4 – Connection of 4 LC fiber cables and a DDC cable	1-4
Figure 5 – Connection of AC/DC power adaptor	1-4
Figure 6 – Connection for Self-EDID programming	1-5
Figure 7 – Connection of 4 LC fiber cables	1-6
Figure 8 – Connection of AC/DC power adaptor	1-6

Welcome!

Congratulations on your purchase of the M1-3R2VI-DU, Optical Dual Link DVI Module. This manual contains information that will assist you in installing and operating the product.

Product Description

The M1-3R2VI-DU module offers 100meters extension of dual link high-resolution digital graphic data over fiber, directly connected between PC and displays, supporting dual link DVI. Two boxes, located one by the PC and the other by the display are connected to each of them with a 1.0 m dual link DVI copper cable. Between two boxes, 7 channels (R, G, B, Clk, R2, G2, B2) of graphic data enables to be transmitted over the 4 LC single or multi-mode fiber bundled cable and the Digital Display Channel (DDC2B) interface is performed over a CAT5e cable, so called as DDC cable, which has RJ-45C connectors.

The M1-3R2VI-DU also provides 2km extension over 4 single mode fibers using virtual DDC mode without CAT5e connection. The EDID (Extended Display Identification Data) in a display can be read and restored by just plugging once transmitter to the display. This **Self-EDID programming** feature makes the installation of M1-3R2VI-DU easier and more flexible at any variable resolution display systems.

For your convenience, Factory EDID default is set to WQXGA (2560x1600).

Shipping Group of M1-3R2VI-DU Optical Dual Link DVI Module

- **Tx and Rx boxes:** One (1) Transmitter (Tx) Box and One (1) Receiver (Rx) Box.
- **Two (2) dual link DVI copper cables:** 1.0m
- **AC/DC power adapter:** One (1) +24V unit
- **User's Manual**
- **Option: DDC cable (UTP for LAN) with RJ-45C.**
- **Option: 4 LC Patch Cord fiber bundled cable (Single or Multi mode glass fiber).**
- **Option: Two +24V AC/DC power adapters are required for virtual DDC.**

1-1 Welcome, Product Description

System Requirements for Setup

- **Hardware requirements**
 - You have a Media Receiver or a graphic controller card with a Dual link port in your Windows/Mac (Mac is option), or SUN system. It should support the maximum graphic resolution feature of the display to be connected.
 - In case of using a computer, no special memory size, CPU speed and chipsets are required.
 - Proper initial trial of the entire platform with its application using a short length copper cable is recommended prior to install with the optical link.
- **Software requirements**
 - No special needs, if the Dual link graphic controller and display peripheral are operational with the platform's OS and application.
- **AC/DC Power Adapter Technical Advisory**

Direct DDC: One power adaptor is required to supply power to both modules of Tx and Rx over the CAT5e cable by plugging the power jack to either of their power plugs.

Virtual DDC: Two power adapters are required to supply power to Tx and Rx module due to no use of the CAT5e cable for DDC.

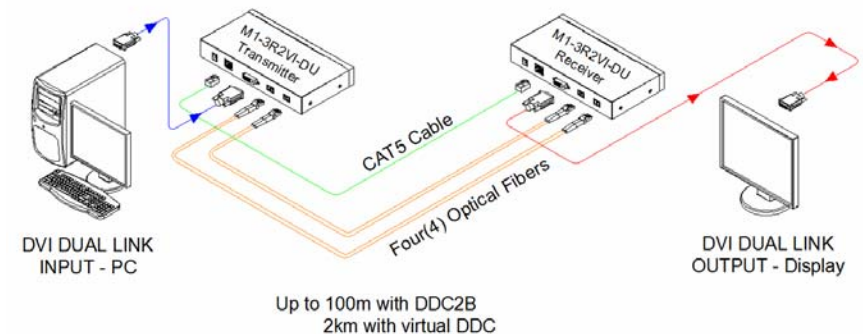

Figure 1 – Overall Optical dual link DVI Module

1-2 System Requirements for Setup

Installation – Direct DDC (Use this menu when DDC through CAT5e)

Important: Please use the installation procedure below. Improper, or no operation may result if the start-up sequence is not correctly followed.

Step 1

Check that the transmitter and receiver are turned off. Set “DDC connection” switch to “Direct DDC” position on the front panel of the transmitter.

Step 2

Connect the upstream Transmitter box to the DVI receptacle of PC through one dual link DVI copper cable (included).

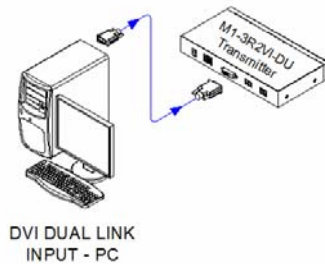

Figure 2 – Connection of DVI cable between Transmitter box and PC

Step 3

In the same way as above, connect the Receiver box into the DVI receptacle of the display through the other dual link DVI copper cable.

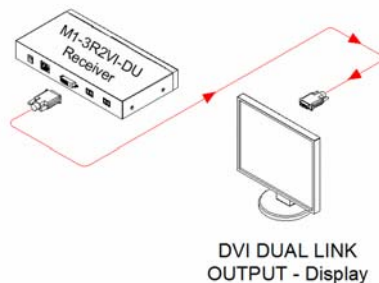

Figure 3 – Connection of DVI cable between Receiver box and the display

Warning: Please DO NOT look directly into the LC receptacles of the Transmitter box, while it is turned on, although this product is strictly regulated enough to operate under the Laser Class I, classified by CDRH/FDA for eye safety.

1-3 Installation

Step 4

Remove the module dust covers and connect each duplex LC fiber cable one by one to each of 4 LC receptacles of the Transmitter and Receiver boxes, as shown in Fig. 4. Plug channel 1 to 1 and channel 2 to 2. Carefully recheck polarities and ensure the duplex connectors are fully engaged.

Step 5

Connect each RJ-45C of the CAT5e cable to each RJ-45C receptacle of the Transmitter and Receiver boxes.

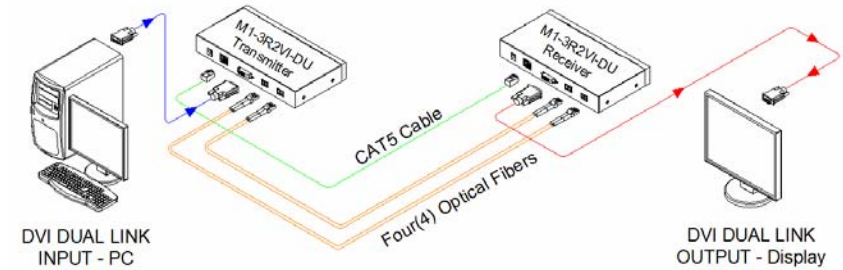

Figure 4 – Connection of 4 LC fiber cables and a DDC cable

Note : Connection for single link DVI

For single link DVI use, one duplex fiber or two simplex fibers are required to be plugged to one port marked “Channel 1”.

Step 6

Connect an AC/DC power adaptor to the DC input terminal either of Transmitter and Receiver boxes as your availability of AC outlets.

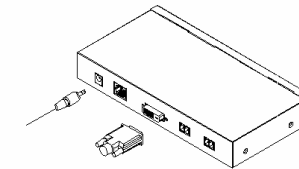

Figure 5 – Connection of AC/DC power adaptor

Step 7

Plug the AC/DC power adaptor into AC outlet. Turn ON the PC.

Tip 1: After initial installation as guided in the above, we recommend you to power On and Off while all connections are set and the Tx/Rx boxes are powered in.

1-4 Installation (continued)

Installation – Virtual DDC (Use this menu without DDC through CAT5e)

Important: Please use the installation procedure below. Improper or no operation may result if the start-up sequence is not correctly followed.

Step 1

Check that the transmitter and receiver are turned off. Set “DDC connection switch to “Virtual DDC” position on the front panel of the transmitter.

Step 2

For Self EDID programming;

- Plug the +24V power adapter to the power jack of the transmitter, and connect the adapter into AC outlet. Ensure “Power” and “EDID PRGM” LEDs are turned ON.
- Push the “Self-EDID” button on the front side of Tx box. The “EDID PRGM” LED is turned ON after blinking twice. The “Status” LED is turned ON.



Note: Please, DO NOT connect the Tx to the display without pushing the “Self-EDID” button. The display may be damaged by unnecessary power supply through pin16 of DVI connector.

- Connect the powered transmitter to the powered display through DVI dual link cable, not to the PC. The LED blinking for 8~10 seconds indicates reading the EDID data. “EDID PRGM” LED is turned OFF after blinking and programming is done.

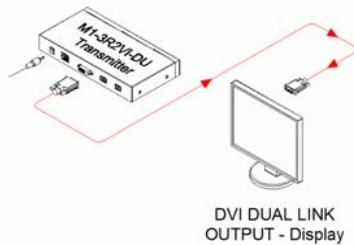

Figure 6 – Connection for Self-EDID programming

- Disconnect the transmitter from the display and the power adapter.

Note: If you want to change the display, please do again the step 2. The EDID factory default is programmed with the VESA standard of WQXGA (2560x1600) 60Hz.

1-5 Installation (continued)

Step 3

Check that the transmitter and receiver are turned off and connect the upstream Transmitter box to the DVI receptacle of PC by one dual link DVI copper cable in the shipping group.

Step 4

In the same way as above, connect the Receiver box into the DVI receptacle of the display by the other dual link DVI copper cable.

Step 5

Remove the module dust covers and connect each duplex LC fiber cable one by one to each of 2 LC duplex receptacles of the Transmitter and Receiver boxes, as shown in Fig. 7. Plug channel 1 to 1 and channel 2 to 2. Carefully recheck polarities and ensure the duplex connectors are fully engaged.

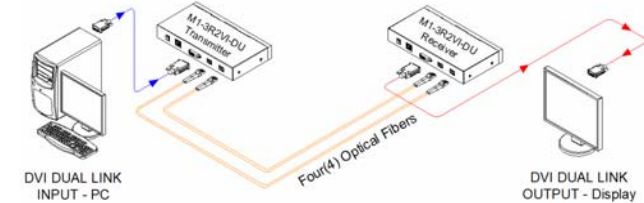

Figure 7 – Connection of 4 LC fiber cables

Note : Connection for single link DVI

For single link DVI use, one duplex fiber or two simplex fibers is required to be plugged to one port marked “Channel 1”. Note that self-EDID programming is also applicable in connection for single link DVI.

Step 6

Connect two AC/DC power adapters to each of the DC input terminals of the Transmitter and Receiver boxes.

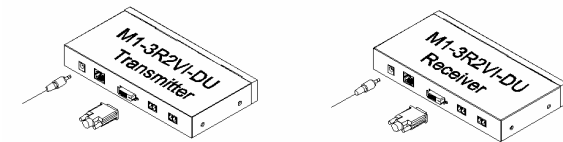

Figure 8 – Connection of AC/DC power adaptor

Step 7

Plug the AC/DC power adapter into AC outlet. Turn ON the PC.

Tip 1: After initial installation as guided in the above, we recommend you to turn On and Off PC while all connections are set and the Tx/Rx boxes are powered in.

1-6 Installation (continued)

Troubleshooting

The display displays only black screen.

- Check that all AC and DC plugs and jacks used by external power supplies (both Opticis and others) are firmly connected.
- Ensure that power is turned on.
- Ensure that the Tx and Rx boxes plug correctly to the PC and display, respectively.
- Check if the PC and display are powered on and properly booted.
- Re-boot up the system after reconnecting the optical system cable.

Screen is distorted or displays noises..

- Reset the system.
- Turn off, disconnect the LC-LC fiber cable and try to blow inside of each LC receptacle by air blower
- Reconnect the fiber cable and turn on.
- If noise continues, please contact the following.

Maintenance

No special maintenance is required for the optical system cables and power supplies. Ensure that the cables and power modules are stored or used in a benign environment free from liquid or dirt contamination.

There are no user serviceable parts. Refer all service and repair issues to Opticis or its authorized distributor.

Technical Support and Service

For commercial or general product support, contact your reseller. For technical service, contact Opticis by email techsupp@opticis.com or visit its website at www.opticis.com.

Product Specifications

M1-3R2VI-DU Optical Dual Link DVI Module

- **Fully backward compatible with DVI standard:** supports DVI 1.0, using fiber-optic communication links and DDC2B.
- **Extension limit:**
 - 100m (330feet) for 2,560x1,600 (1.65Gbps) with Direct DDC.
 - 2km (6,560feet) for 2,560x1,600 (1.65Gbps) with Virtual DDC.
- **Graphic Transmission Bandwidth:** supports up to 1.65Gbps bandwidth per graphic channel.
- **Fiber-optic Connection:** The transmitter and receiver boxes of M1-3R2VI-DU have 2 duplex LC receptacles connected to four (4) 9(8)/125µm Single-Mode or 62.5(50)/125µm Multi-Mode glass fibers cables.
- **Mechanical specifications of Tx and Rx boxes**
 - **Dimensions:** 216mm / 31mm / 112mm (W/H/D)
 - **Weight:** 380 ± 20 gr for each of Tx and Rx.
- **Environmental Specifications**
 - Operating temperature: 0°C to 50°C
 - Storage temperature: -10°C to 85°C
 - Humidity: 5% to 85%

AC/DC Power Adapter

- **Power Input:** Universal AC 85-264V, 50/60Hz, AC power cord with power jack.
- **Power Output:** +24 V, 2.5 A SMPS DC-power Adapter
- **Cord DC Jack & length:** Core is +24 V and outer cylinder is GND. Length is 18.5 cm
- **AC Cord length:** 1.8m
- **Certification:** PSE, UL, cUL, FCC, CE, TUV-GS



Warranty Information

1 (One) Year Warranty

Opticis warrants this optical dual link DVI module to be free from defects in workmanship and materials, under normal use and service, for a period of one (1) year from the date of purchase from Opticis or its authorized resellers.

If a product does not work as warranted during the applicable warranty period, Opticis shall, at its option and expense, repair the defective product or part, deliver to customer an equivalent product or part to replace the defective item, or refund to customer the purchase price paid for the defective product.

All products that are replaced will become the property of Opticis.

Replacement products may be new or reconditioned.

Any replaced or repaired product or part has a ninety (90) day warranty or the remainder of the initial warranty period, whichever is longer.

Opticis shall not be responsible for any software, firmware, information, or memory data of customer contained in, stored on, or integrated with any products returned to Opticis for repair under warranty or not.

Warranty Limitation and Exclusion

Opticis shall have no further obligation under the foregoing limited warranty if the product has been damaged due to abuse, misuse, neglect, accident, unusual physical or electrical stress, unauthorized modifications, tampering, alterations, or service other than by Opticis or its authorized agents, causes other than from ordinary use or failure to properly use the product in the application for which said product is intended.

Dispose of Old Electrical & Electronic Equipment

(Applicable in the European Union and other European countries with separate systems)



This symbol on the product or on its packaging indicates that this product shall not be treated as household waste. Instead it shall be handed over to the applicable collection point for the recycling of electrical and electronic equipment. By ensuring this product is disposed of correctly, you will help prevent potential negative consequences for the environment and human health, which could otherwise be caused by inappropriate waste handling of this product.

The recycling of materials will help to conserve natural resources. For more detailed information about recycling of this product, please contact your local city office, your household waste disposal service or the shop where you purchased the product.

1-9 Warranty Information

FCC/CE Statement for regulation of Electro-magnetic emission

This device complies with part 15 of FCC Rules. Operation is subject to the following two conditions: (1) this device may not cause harmful interference, and (2) this device must accept any interference received, including interference that may cause undesired operation. This equipment has been tested and found to comply with the limits for a Class B digital device, pursuant to part 15 and 2 of FCC Rules, EN 55022/55024/61000-3 for CE certification. These limits are designed to provide reasonable protection against harmful interference when the equipment is operated in a residential installation. This equipment generates, uses, and can radiate radio frequency energy and, if not installed and used in accordance with the instruction guide, may cause harmful interference to radio communications. However, there is no guarantee that interference will not occur in a particular installation. If this equipment does cause harmful interference to radio or television reception, which can be determined by turning the equipment off and on, the user is encouraged to try to correct the interference by one or more of the following measures:

- Re-orient or relocate the receiving antenna.
- Increase the separation between the equipment and the receiver.
- Connect the equipment into an outlet on a circuit different from that to which the receiver is connected.
- Consult a service representative for help.

Properly shielded and grounded cables and connectors must be used in order to comply with FCC/CE emission limits. Changes or modifications not expressly approved by the party responsible for compliance could void the user's authority to operate the equipment.

Certification for Safety

The AC/DC power adapter is certified by UL1310, 1950, 60950 for North America, cUL or CSA for Canada, TUV-CE & GS for EU and PSE for Japan.

Certification of Eye Safety

This laser product is inside implemented by using 1310, 1550nm LD Transceivers, manufactured by Opticis Co., Ltd., which are all certified by CDRH/FDA referred as classified in Laser Class 1.

1-10 Regulatory Statements

Opticis Locations

Opticis Co., Ltd.
#501 Byucksan Technopia, 434-6,
Sangdaewon-Dong, Chungwon-Ku,
Sungnam City, Kyungki-Do,
462-120, South Korea
Tel: +82 (31) 737-8033
Fax: +82 (31) 737-8079

Opticis North America Ltd.
330Richmond Street, Suite 100,
Ontario N7M 1P7
Canada
Tel: +1 (519) 355-0819
Fax:+1 (519) 355-0520

For order support, please contact your Distributor or Reseller.

For technical support, check with the Opticis web site www.opticis.com or
contact techsupp@opticis.com