

RANE

TTM 57SL
PERFORMANCE MIXER

serato™



SCRATCH LIVE

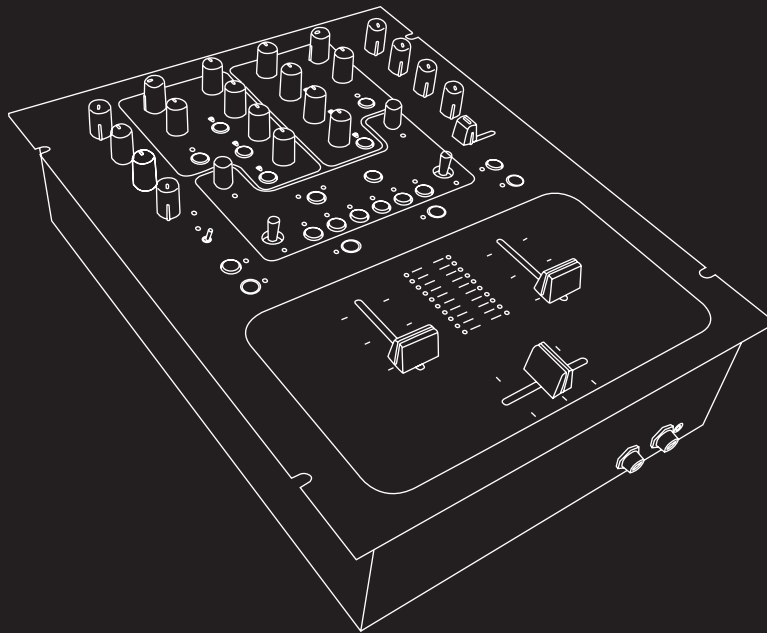

TTM 57SL FOR SERATO SCRATCH LIVE • OPERATOR'S MANUAL 2.2

IMPORTANT SAFETY INSTRUCTIONS

1. Read these instructions.
2. Keep these instructions.
3. Heed all warnings.
4. Follow all instructions.
5. Do not use this apparatus near water.
6. Clean only with a dry cloth.
7. Do not block any ventilation openings. Install in accordance with manufacturer's instructions.
8. Do not install near any heat sources such as radiators, registers, stoves, or other apparatus (including amplifiers) that produce heat.
9. Do not defeat the safety purpose of the polarized or grounding type plug. A polarized plug has two blades with one wider than the other. A grounding-type plug has two blades and a third grounding prong. The wide blade or third prong is provided for your safety. If the provided plug does not fit into your outlet, consult an electrician for replacement of the obsolete outlet.
10. Protect the power cord and plug from being walked on or pinched particularly at plugs, convenience receptacles, and the point where it exits from the apparatus.
11. Only use attachments & accessories specified by Rane.
12. Use only with the cart, stand, tripod, bracket, or table specified by the manufacturer, or sold with the apparatus. When a cart is used, use caution when moving the cart/apparatus combination to avoid injury from tip-over.
13. Unplug this apparatus during lightning storms or when unused for long periods of time.
14. Refer all servicing to qualified service personnel. Servicing is required when the apparatus has been damaged in any way, such as power supply cord or plug is damaged, liquid has been spilled or objects have fallen into the apparatus, the apparatus has been exposed to rain or moisture, does not operate normally, or has been dropped.
15. The plug on the power cord is the AC mains disconnect device and must remain readily operable.
16. This apparatus shall be connected to a mains socket outlet with a protective earthing connection.
17. When permanently connected, an all-pole mains switch with a contact separation of at least 3 mm in each pole shall be incorporated in the electrical installation of the building.
18. If rack-mounting, provide adequate ventilation. Equipment may be located above or below this apparatus, but some equipment (like large power amplifiers) may cause an unacceptable amount of hum or may generate too much heat and degrade the performance of this apparatus.

WARNING: To reduce the risk of fire or electric shock, do not expose this apparatus to rain or moisture. Apparatus shall not be exposed to dripping or splashing and no objects filled with liquids, such as vases, shall be placed on the apparatus.

INTRODUCTION

Please read through these operating instructions so you will know how to get the most from your TTM 57SL and the included Scratch Live software. Keep this manual in a safe place. If you ever lose it, a new copy may be downloaded at rane.com/ttm57sl.html.

To keep up with the latest tips, and to check for software updates for your TTM 57SL, visit the Official Scratch Live Forum at serato.com.

COPYRIGHT NOTICES

© 2010 Rane Corporation. All rights reserved. Scratch Live and the Scratch Live logo are trademarks of Serato Audio Research. Trademarked in the U.S. and other countries. Licensed exclusively to Rane Corporation. This software is based in part on the work of the Independent JPEG Group, and uses libpng code, copyright © 2000-2002 Glenn Randers-Pehrson. The Scratch Live Control Tone, the audio pressed on Scratch Live Control vinyl and Control CDs, is copyright ©2004-2010 Serato Audio Research. The Control Vinyl and Control CDs are licensed for personal use only. The creation of personal backups of the Control CD is allowed, however duplicating Control CDs for commercial benefit is strictly prohibited. For avoidance of doubt the duplication or creation of Control vinyl for any use is strictly prohibited. Please respect our copyright. ©2004-2010 Serato Audio Research. Windows XP, Vista and 7 is either a registered trademark or a trademark of Microsoft Corporation in the United States and/or other countries. Apple, Mac, Macintosh and iTunes are trademarks of Apple Computer, Inc., registered in the US and/or other countries.

WARNING

To reduce the risk of electrical shock, do not open the unit. No user serviceable parts inside. Refer servicing to qualified service personnel. The symbols shown below are internationally accepted symbols that warn of potential hazards with electrical products.

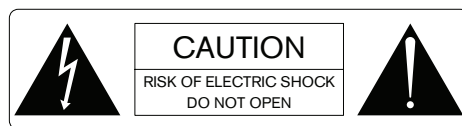

This symbol indicates that there are important operating and maintenance instructions in the literature accompanying this unit.



This symbol indicates that a dangerous voltage constituting a risk of electric shock is present within this unit.

MINIMUM SYSTEM REQUIREMENTS

- At least one turntable or CD player.

PC

- Windows XP with Service Pack 3 or higher, or Vista with Service Pack 2 or higher, or Windows 7. We recommend Windows 7 over Vista.
- 1.6 GHz processor (please read the FAQ at serato.com before buying a new PC).
- 2 GB RAM.
- Screen resolution 1024 x 768 or higher.
- Hard drive space for storing music.
- Available USB port.

MAC

- Mac OSX 10.4.11 or higher.
- 1 GHz G4.
- 2 GB RAM.
- Screen resolution 1024 x 768 or higher.
- Hard drive space for storing music.
- Available USB port.
- Scratch Live is compatible with Intel-based Mac computers.

PLEASE NOTE: These are the minimum requirements to run Serato Scratch Live without optional plugins. For best performance or when using optional plugins we recommend you use a higher spec computer. For more information please visit www.serato.com/scratchlive#minspecs.

CHECK LIST

These items are included with the TTM 57SL in the box:

- Scratch Live software install disc.
- 2 (two) control CDs.
- 2 (two) control records.
- 1 USB cable.
- IEC C5 line cord.
- Package of 4 rubber feet.
- Quick Start Guide.
- This manual.

CONTENTS

Important Safety Instructions	3	Master Cue	9	Tracking Indicator	17
Minimum System Requirements	3	FlexFX Loop	9	Tap Tempo	17
TTM 57SL MIXER OVERVIEW	6	GETTING STARTED	10	Key Lock	17
Scratch Live Control Surface	6	Installing Scratch Live	10	Repeat	17
Effects	6	TTM 57SL as a Sound Card	10	Censor	17
Advanced Recording Capabilities	6	Starting the Software	10	Eject	17
External Sound Card Interface	6	Installing More Than One Version	11	Autoplay	17
Magnetic Faders	6	Firmware Check	11	Reverse Input Control	17
Hardware Features	6	Using the Tool Tips	11	Track Gain	17
Wear Parts	6	Connecting Your Hardware	11	USB Dropout Indicator	18
CONNECTING THE MIXER	7	System Overview	11	DISPLAY MODES	18
PGM Inputs 1-4	7	Turntable Setup	11	LIBRARY VIEWS	18
Mic Input	7	CD Player Setup	11	SCRATCH LIVE MODES	19
Analog Outputs	7	CALIBRATING SCRATCH LIVE	12	Absolute Mode	19
USB Streaming Audio	7	The Noise Threshold	12	Relative Mode	19
Power Supply	7	How to Calibrate Scratch Live	12	Internal Mode	20
Input	8	The Scopes	12	Temporary Cue	20
Gain	8	Calibration Troubleshooting	12	More Controls	20
Pan	8	IMPORTING AND PLAYING MUSIC	13	CUE POINTS	21
High / Mid / Low EQ	8	Importing Your Music	13	Setting Cue Points	21
Faders	8	Supported File Types	13	Enable Hot Cues	21
Contour	8	Playing Music	13	Triggering Cue Points	21
Reverse	8	Track Display	13	Editing Cue Points	21
Channel Swap	8	WHITELABEL.NET	14	Customizing Cue Points	21
Meter	8	PREPARING YOUR FILES	14	LOOPING	21
MIXER CONTROLS	8	How to Analyze Files	14	Auto Looping	22
Aux In	9	About Corrupt Files	14	The A - Slot	22
Mic Level and EQ	9	Set Auto-BPM	14	Loop Roll	22
Output Levels	9	The Offline Player	14	Loop Roll with MIDI	22
Headphone Cueing	9	PLAYBACK CONTROL	15	SP-6 SAMPLE PLAYER	23
Phones	9	The Control Record	15	Loading the SP-6	23
Cue	9	The Control CD	15	Playing Samples	23
		Vinyl Scroll	15	SP-6 Instant Doubles	23
		MAIN SCREEN OVERVIEW	16	SP-6 Play Modes	23
		Virtual Deck	16	SP-6 Pitch Controls	24
		Visual Aids	16	SP-6 'Play From' Selector	24
		Tempo Matching Display	16	SP-6 Track Overviews	24
		Track Overview Display	16	SP-6 Slot Volumes	24
		Main Waveform Display	16	SP-6 Output Selector	24
		Beat Matching Display	16	Individual Output Selectors	24
		Master Gain	17	SP-6 Sample Banks	24
		33 / 45 Speeds	17	SP-6 Mute Buttons	24
				SP-6 MIDI	24

DJ-FX PLUGIN	25	MIXING WITH ONE TURNTABLE OR CD PLAYER	33	Import AAC Files	37
Ultra Knob Mode	25			Font Size	37
Super Knob Mode	25			Album Art Size	37
Effects BPM Multiplier	25	ADDITIONAL SETUP	33	Display	37
Deck Assign	25	Hardware	33	Maximum Screen Updates	37
Show Parameters	25	USB Buffer Size (Latency)	33	Audio Cache	37
Macro Edit Mode	25	Update Firmware	33	Show Album Art On Deck	37
		Save to Mixer	34	Plugins	37
MIDI CONTROL	26	Phono Sensitivity	34	SP-6 Sample Player	37
MIDI Controller Setup	26	Transform Direction	34	DJ-FX	37
Assigning Controls	26	Latch Kill Switches	34	Serato Playlists	37
MIDI Platters	26	Meters	34		
Assigning MIDI to other Controls	26	Phones	34	THE HARDWARE CONTROL PANEL	38
Ctrl-Click Functionality	26	Expand Library on Track Scroll	34	TTM 57SL Control of Scratch Live	38
Presets	26	Flashing Deck Indicator	34	Groups	38
Native Controller support	26	Foot switch Type	34	Customizing Control Assignments	38
MIDI Devices	27	Reset Controls to Default	34	TTM 57SL Control of DJ-FX	38
Technical Information	27	Control Source	34	Default Control Assignments	38
		Effect 1 & Effect 2	34		
ORGANIZING YOUR MUSIC	27	Playback	34	EFFECTS	41
Grouping Tracks into Crates	27	Track End Warning	34	Hardware & Software Control Panels	41
Subcrates	27	Playback Keys Use Shift	34	Internal Digital Effects	41
Smart Crates	27	Lock Playing Deck	34	Group 6	41
Sorting Your Files	28	Sort Cues Chronologically	34	Inserting an Effect	41
Using the Song Browser	28	Enable Hot Cues	34	Basic Effects Controls	42
Searching	28	Use Auto Gain	35	Footswitch	42
Prepare Window	28	Hi-Fi Resampler	35	Effects Cueing	42
History	29	Play From Start	35	Control Assignment Summary	42
Serato Playlists	29	Instant Doubles	35		
Uploading Serato Playlists	29	Play From First Cue Point	35	MAGNETIC FADER Q AND A	48
Live Playlists	30	Braking (Internal Mode)	35	MAGNETIC FADER CLEANING	49
Editing ID3 tags	30	Audio Output	35	TROUBLESHOOTING AND FAQs	50
Library Zoom	30	Vinyl Control	35	CORRUPT FILE DESCRIPTIONS	51
Display Album Art	30	Adjust Loops with Vinyl	35	SCOPE READING AND FIXES	52
Adding Album Art	30	Next Song on Flip	35	KEYBOARD SHORTCUTS	54
Status Icons	30	Enable Vinyl Scroll	35	FOOTSWITCH DIAGRAM	55
More Info on Corrupt Files	30	Reverse Vinyl Scroll	35	DSP PROCESSING BLOCK DIAGRAM	56
		Vinyl Scroll Speed	35	DECLARATION OF CONFORMITY	57
FILE MANAGEMENT	31	Drop to Absolute Position	35	LIMITED WARRANTY	58
Rescan ID3 Tags	31	Drop to Cue Points	36		
Relocate Lost Files	31	Vinyl Start Offset	36		
Deleting Crates & Tracks	31	Library	36		
Copying & Moving Files & Folders	31	Read iTunes Library	36		
Copying and Moving Crates	31	Protect library	36		
Scratch Live Backup	31	Customize Crate Views	36		
		Center on Selected Song	36		
RECORDING	32	Show All File Types	36		
		Include Subcrate Tracks	36		
LIVEFEED	32	Autofill Overviews	36		

TTM 57SL MIXER OVERVIEW

The TTM 57SL Performance Mixer combines the best technologies that Rane and Serato have to offer in a single high-performance mixer. The TTM 57SL fully integrates Rane's proven hardware and Serato Scratch Live, creating a whole new range of possibilities for your performance. The TTM 57SL was specifically designed to work with Scratch Live and the available features are best served when used with Scratch Live. The TTM 57SL is also a very competent standalone performance mixer.

The features and functionality of your mixer will improve with new releases of the Scratch Live software – and all Scratch Live updates are free.

SCRATCH LIVE CONTROL SURFACE

Control Scratch Live without taking your hands off the mixer. Navigate through your library, load tracks, hit cues, loop and control effects via the integrated control surface. Control includes an input for connecting a footswitch for hands free looping, sampling and effects.

EFFECTS

24-bit effects using Rane and Serato's award winning studio and live sound software technologies give you professional studio quality sound. The mixer comes with Echo and Filter effects.

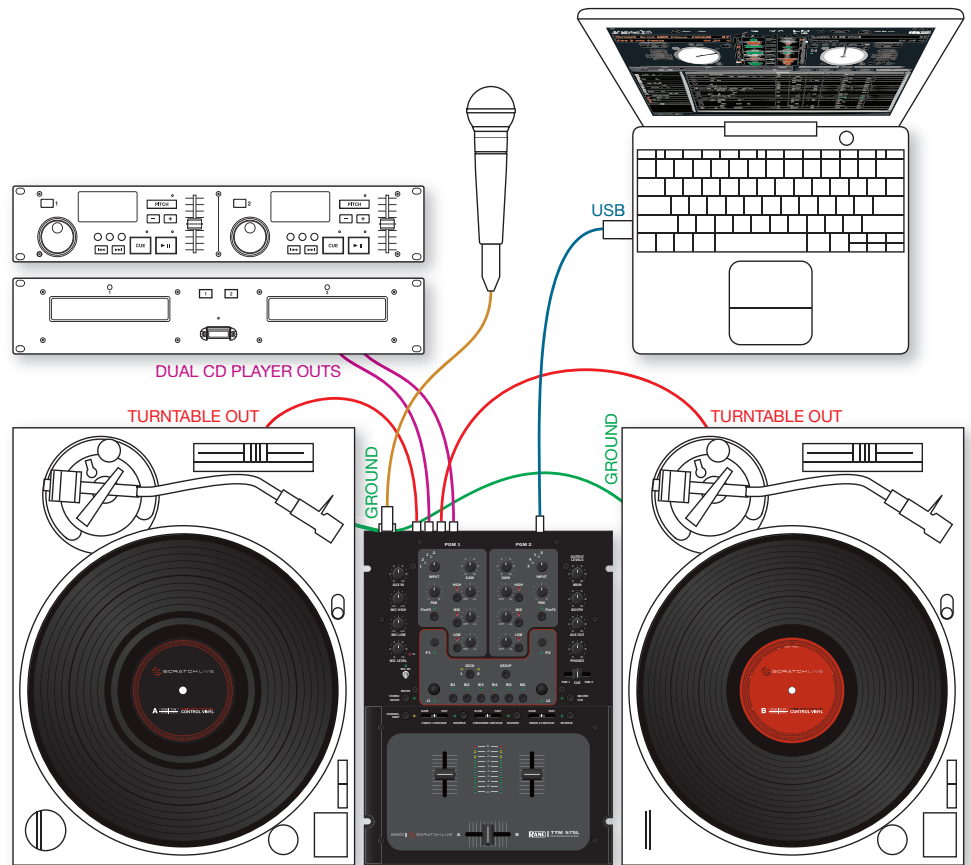

ADVANCED RECORDING CAPABILITIES

Record your mix directly to hard drive.

EXTERNAL SOUND CARD INTERFACE

Use the TTM 57SL as a high quality USB audio interface for your favorite Mac or PC software – USB 1.1 with 8 channels of streaming 16 bit / 44.1 kHz audio with onboard DSP effects processing.

MAGNETIC FADERS

Rane's legendary patented magnetic faders are the fastest, most accurate, and longest lasting on the planet. The TTM 57SL uses the same faders and performance oriented layout that made the TTM 56 famous.

HARDWARE FEATURES

- Internal universal power supply works in almost any country (100-240 VAC).
- 4 line / phono switchable inputs.
- “Kills” on each EQ band, on each bus; six total.
- Dual headphone outputs: ¼" jack and 3.5 mm mini-jack.
- Rane's famous “FlexFX” effects loop system, in addition to built-in effects.
- RCA, ¼" and XLR outputs, each with an independent volume control.
- USB 1.1 with 8 channels of streaming 16-bit / 44.1 kHz audio.
- Mic input EQ and Engage switch.

WEAR PARTS

The TTM 57SL Mixer contains no wear parts. The vinyl records and CDs are wear parts as described in the “Factory Authorized Service” on page 58.

CONNECTING THE MIXER

Leave the power unplugged until everything else is connected!

PGM INPUTS 1-4

The TTM 57SL has two stereo analog inputs for PGM 1 and two stereo analog inputs for PGM 2. Any of these analog inputs may be set for Line Input or Phono Input using the LINE / PHONO switches located on the rear panel. Up is LINE and Down is PHONO. Unused inputs are best set to LINE. Attach your turntable's ground wires to the Phono Ground connectors.

Two stereo digital inputs from the USB connection, Digital 1 and Digital 2, are also available for PGM 1 and PGM 2. It is possible to select any combination of digital and analog signals.

Any of the four analog inputs may be used for Scratch Live vinyl emulation control. Input 1 or Input 2 may be selected for Scratch Live Virtual Deck 1 control. Input 3 or 4 may be selected for Scratch Live Virtual Deck 2 control. Control input sources are selected using the Scratch Live software. As will be discussed later in Program Controls, if a source has been selected for vinyl emulation control by the Scratch Live software, the number is back-lit as a reminder that the source is selected for control.

SET THE UNUSED INPUTS TO LINE

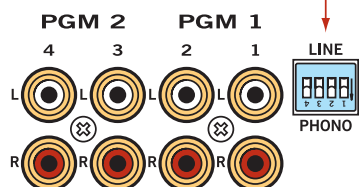

MIC INPUT

The Mic Input will accept either a balanced ¼" TRS (tip-ring sleeve) plug or an unbalanced TS (tip-sleeve) plug. Any type of microphone may be used, except those that require phantom power to operate. **SEE "MIC LEVEL AND EQ" ON PAGE 9.**



ANALOG OUTPUTS

Main, Booth and Aux outputs each have their own Level control, and all come from the same "Main Mix" signal. The Main output is on balanced XLR jacks with pin 2 "hot" per AES standards. The Booth output is on balanced ¼" TRS (tip-ring-sleeve) jacks, though unbalanced TS (tip-sleeve) plugs may be used. The Aux output is on regular unbalanced RCA jacks. Because all signals are identical, users may use any of these outputs as the "main" output if a different cable type is required for system connection.

Rane recommends balanced wiring for the strongest signal and rejection of hum and noise. If your cable to the amp rack is less than 10 feet (3 meters), you can often get away with an unbalanced cable. See the RaneNote "[Sound System Interconnection](#)" at www.rane.com for details and cable wiring.

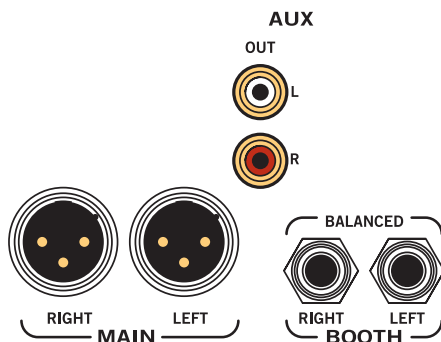

USB STREAMING AUDIO

There are eight channels of streaming audio over the USB port. Two stereo channels from the computer and two stereo channels to the computer. While internal processing is all 24-bit 44.1 kHz, streaming audio is 16-bit 44.1 kHz. If the blue indicator is on, the device is connected and communicating with the computer.



Two stereo signals from the computer appear as Digital 1 and Digital 2 inputs. These stereo digital signals may be selected for PGM 1 and/or PGM 2 (see source selection in the Program Controls section). As well as the two stereo channels sent to the computer for vinyl emulation control, one stereo pair can also be sent to your computer for recording. **SEE "RECORDING" ON PAGE 32.**

When not using the Scratch Live software, the mixer appears as two four-channel sound cards with stereo in and stereo out. The source for the stereo output channels must be selected in your software. The following signals may be selected as the source for either digital output to the computer:

- PGM 1 Pre- or Post- Fader
- PGM 2 Pre- or Post-Fader
- Main Mix
- AUX BUS (sum of the MIC, AUX and FlexFX Return).

POWER SUPPLY

The TTM 57SL features an internal universal switching power supply that operates on any AC mains 100 to 240 VAC, 50 or 60 Hz (most places in the world). All that is required when traveling is the appropriate IEC line cord which is usually readily available. The universal supply is a major plus for the traveling DJ.

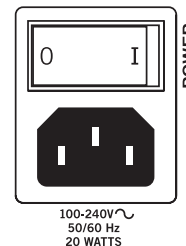

MIXER CONTROLS

INPUT

Choose one of four INPUT sources for each Program.

PGM 1 selects:

- Analog-1 (A1)
- Analog-2 (A2)
- Digital-1 (D1)
- Digital-2 (D2)

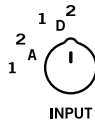

PGM 2 selects:

- Analog-3 (A3)
- Analog-4 (A4)
- Digital-1 (D1)
- Digital-2 (D2)

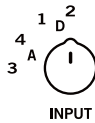

The Analog Inputs come from your turntables or CD players. The Digital Inputs come from the Virtual Decks in the Scratch Live software. If the number for A1 or A2 is illuminated, the Input has been selected by the Scratch Live software as the control source input for Deck One. If the number for A3 or A4 is illuminated, the Input has been selected by Scratch Live as the control source input for Deck Two. The backlit number is a reminder that this source may be a control signal and not audio. You may select a control input and use it as a normal analog input at any time without de-selecting it for control in Scratch Live, but remember that if you are playing a control record or CD, you will hear the control signal. **SEE "CONTROL SOURCE" ON PAGE 34.**

GAIN

These "trim" controls adjust the selected input to match other inputs. These controls have a built-in Limiter that prevents the signal from clipping regardless of the Gain setting. If increasing the Gain does not increase the signal level, then the signal is already at maximum and the Limiter is controlling the signal to prevent clipping. The Gain range is +15 dB to off.



PAN

These controls pan the signal between the Left and Right outputs.

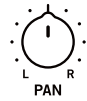

HIGH / MID / LOW EQ

The control range is OFF to +6 dB. These use 2nd-order, Linkwitz-Riley, Accelerated Slope™ filters. The Low-Mid cross-point is 300 Hz. The Mid-High cross-point is 4 kHz.

Kill switches provide instant-off for each control. The skull lights red and the band is off when its Kill switch is pressed. When the switch is released, the EQ goes back to the setting of its EQ control. These switches may be set to momentary or toggle operation within the Scratch Live software. **SEE "LATCH KILL SWITCHES" ON PAGE 34.**



FADERS

Magnetic faders are used for both Channel Faders and Crossfader (the same faders used in the TTM 56S). Each fader has an independent Contour control and a Reverse switch.

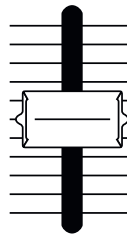

CONTOUR

These controls provide a full range of fader adjustment from constant power (Slow) to extremely fast cut (Fast).

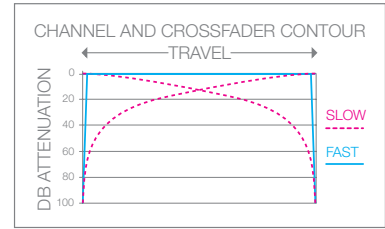

REVERSE

These switches are provided for each fader just to the right of each Contour control. Reverse toggles on (lit green) and off with each push of the switch. These switches are slightly recessed to prevent accidental engagement.



CHANNEL SWAP

This button reverses the channel assignment for all three faders. Pressing the switch toggles Channel Swap on and off. When the yellow indicator is lit, Channel Swap is engaged. When channels are swapped, the PGM 1 Fader controls PGM 2 and the PGM 2 Fader controls PGM 1. PGM 1 is also moved from the A side of the Crossfader to the B side of the Crossfader. Fader Contour and Reverse controls stay with the original Fader. Fader 1 Contour and Reverse is always with the left Fader and Fader 2 Contour and Reverse is always with the right Fader. This switch is slightly recessed to prevent accidental engagement.



METER

The Meter has two modes of operation. The METER switch toggles between Dual Mono Cue and Stereo House.

- When this indicator is lit green, the Meter displays the Stereo Mix sent to all three outputs.
- When this indicator is off, the Meter displays Dual Mono Cue, to show the levels of PGM 1 and PGM 2.



The top red OL indicator lights at 0 dBFS (clipping). The Meter displays loudness with a solid string of lights, and how close you are to clipping with a moving dot. If the red OL indicator lights, turn the level down using the Gain control.

AUX IN

This adjusts the level of the Auxiliary Input signal. This is a full-range control providing Off to +6 dB gain adjustment.



MIC LEVEL AND EQ

The MIC ON switch engages the Mic. The green indicator is lit when the MIC is engaged. MIC LEVEL adjusts the Mic gain over a range of Off to +50 dB. Set the gain where you want it and use the MIC ON switch to turn the MIC on and off. The OL indicator lights when the signal reaches clipping. If this lights red, turn the MIC LEVEL down. MIC HIGH and MIC LOW tone controls allow you to adjust the bass and treble of the MIC Input signal.

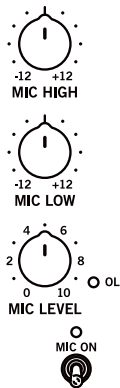

OUTPUT LEVELS

Output Level controls are provided for MAIN, BOOTH and AUX Outputs. All three outputs have the same Main Mix source. As shown previously in Analog Outputs (on page Manual-3), the Main output is a balanced output on XLR connectors, the Booth output is a balanced signal on TRS connectors and the AUX output is an unbalanced signal on RCA connectors. This combination of jacks allows you to hook into other equipment regardless of the connector type.



HEADPHONE CUEING

The Cueing system allows users to Pan the Cue from PGM 1 to PGM 2 or select the Master Mix. Cueing is also provided for the internal digital effects, **COVERED ON PAGE-10**. Both 3.5 mm and 1/4" jacks are provided. These can be used simultaneously, but using only one at a time yields more power to the headphones.

PHONES

The headphone output can deliver very high volume to some headphones. To avoid pain, never put headphones on your head before plugging them in. Always start with the PHONES Level turned down, and then turn it up to the desired level.



CUE

This slider pans between PGM 1 and PGM 2 in the headphones when the Master Cue light is off. When Master Cue is on, this control has no effect. The cue signals are post-EQ and pre-fader.



MASTER CUE

Press this switch (green light on) to hear the Main Mix in the headphones. When this light is off, the Cue slider takes over.



FLEXFX LOOP

This stereo loop connects an external effects processor, post-fader. The signals coming from the PGM 1 fader, the PGM 2 fader, or both may be routed to the FlexFX loop. This allows a single external effects unit to process PGM 1 and/or PGM 2.



NOTE: This Loop is for an external effects unit. For details on the built-in internal effects, SEE "EFFECTS" ON PAGE 41.

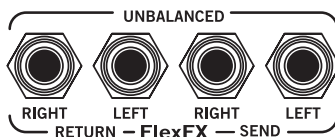

FlexFX switches are provided for PGM 1 and PGM 2. Pressing the FlexFX switch lights the green indicator and sends the signal to the external FlexFX Loop. Press the switch again to stop sending signal to the loop (the green indicator goes dark). FlexFX jacks are unbalanced mono 1/4" TS (Tip/Sleeve). SEND jacks provide output to the effects processor. RETURN jacks provide input from the effects processor. Effects insert devices with a single in/out TRS jack place Send on the TIP and Return on the RING. For this application, you will need a "Y" cable, as shown below.

Send signals may be used as another auxiliary output, allowing PGM 1, PGM 2 or both to be routed to an external source (another amp or recorder). If you wish to disconnect your external effects processor, it is not necessary to connect cables from FlexFX Send to FlexFX Return, as the TTM 57SL detects the presence of cables, and automatically connects the Send and Return when a cable is not connected.

Any signal assigned to the FlexFX Loop will be processed by any internal digital effect assigned to the AUX BUS. This has the advantage of allowing one of the two internal effects to be assigned to the AUX BUS and then assigning PGM 1 and/or PGM 2 to the FlexFX Loop.

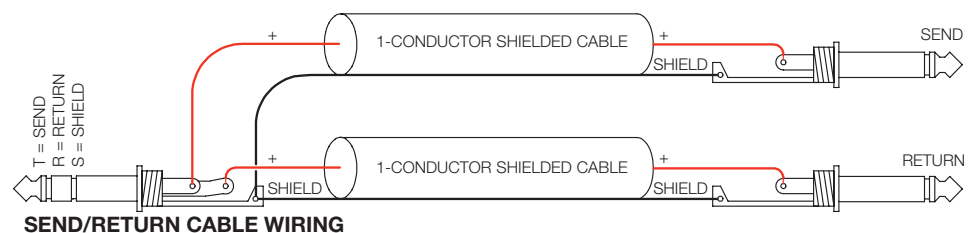

GETTING STARTED

INSTALLING SCRATCH LIVE

Check for the latest download version of Scratch Live software at serato.com. If it is newer than what is on your CD-ROM, we recommend installing it instead.

MAC

1. Insert the Software Installation CD-ROM and double-click the installer icon.
or
Launch the installer you just downloaded from serato.com.
2. Follow the on-screen instructions. Once the installation is complete, Scratch Live will appear in your applications list. You may like to drag the Scratch Live icon to your dock for quick launching.
3. Plug in your TTM 57SL. No extra hardware or driver installation is required.

WINDOWS

It is important that Windows users install the TTM 57SL drivers as well as the Scratch Live software. The easiest way to do this is to allow the Scratch Live installer to do all the work.

1. Connect your TTM 57SL with the USB cable before you insert your installation CD. When you first connect it, Windows will attempt to install the drivers via the hardware wizard. Cancel and close the hardware wizard.

2. Insert the Software Installation CD-ROM. If a window doesn't open automatically, browse to the CD drive. Run `setup.exe`.

or

Launch the installer you just downloaded from serato.com.

3. Follow the on-screen instructions. Once the installation is complete, Scratch Live appears in the Start Menu under All Programs > Serato > Scratch Live.

Because the TTM 57SL was connected prior to installing Scratch Live, no extra hardware installation is required.

NOTE: Select the custom install option if you wish to change the installation location of Scratch Live.

ADDITIONAL WINDOWS DRIVERS

Vista & Windows 7 install the driver for all USB ports at once. Windows XP treats each USB port individually. You might like to install the Drivers for the TTM 57SL on all of your USB ports.

Connect your Scratch Live hardware to a USB port. Windows will again attempt to install the drivers via the hardware wizard. Cancel and close the hardware wizard.

With your hardware still connected, run the Scratch Live driver updater. This is usually located in `C: > Program Files > Serato > driver_updater32.exe` [or for 64-bit systems: `C: > Program Files (x86) > Serato > driver_updater64.exe`.] Repeat this process for each of your USB ports.

TIP: The driver updater can install drivers for different types of Scratch Live hardware. For example, if you play at a club that uses an SL 3, just connect the mixer and run through the driver updater as above.

TTM 57SL AS A SOUND CARD

The TTM 57SL will be available as a standard Windows sound card whenever Scratch Live is not running. It will replace the previous sound card and default to TTM57SL Line 2 (select D 2 on either of the PGM INPUTS).

If you wish to change to Line 1 or back to your previous sound card when not using the TTM 57SL:

1. Start > Control Panel > Sounds & Audio Devices.
2. Click the Audio tab.
3. Make changes using the drop menus for both Sound Playback and Sound Recording.
4. Click OK.

TIP: Be aware that Windows system event sounds (beeps, dings, etc.) will come through your TTM 57SL when it is your sound card. To prevent embarrassment, have no other applications running. Better yet, turn off your computer's sound scheme.

1. Start > Control Panel > Sounds & Audio Devices [in Vista or 7, Control Panel > Sounds].
2. Click the Sounds tab.
3. Under Sound scheme, change to No Sounds.
4. Click OK.

STARTING THE SOFTWARE

Close all other programs on your Mac or PC. When you load Scratch Live for the first time, you will see the screen shown below:



TROUBLESHOOT: The TTM 57SL mixer is not recognized. It takes five seconds for Scratch Live to detect the TTM 57SL. The mixer can be unplugged at any time; you do not need to exit Scratch Live before disconnecting the hardware. Use the supplied USB cable — longer lengths are not recommended. On some Windows machines each USB port is treated separately, so you will need to install the driver separately for each USB port. If the above screen does not show within ten seconds, try unplugging and replugging the USB cable.

INSTALLING MORE THAN ONE VERSION

Installing a new version will by default overwrite any previous version you had installed, however it is easy to have more than one version of Scratch Live installed if you wish.

Mac users: before installing, find the Scratch Live application (by default it is in the Applications folder), and rename it - for example Scratch Live 2.0.0. When you install the new version, the old application will not be overwritten, and you can choose which version you want to run by going into the folder and double clicking on the application. You can also do this if you have already installed the latest version - just rename the application (eg. to Scratch Live 2.1.1), and then reinstall the earlier version.

Windows Users: before installing, find the Scratch Live executable (by default it is in C:\Program files\Serato\ScratchLIVE), and rename it - for example Scratch Live 2.0.0.exe. When you install the new version, the old executable will not be overwritten, and you can choose which version you want to run by going into the folder and double-clicking the executable. You can also do this if you have already installed the latest version - just rename the executable (eg. to Scratch Live 2.1.1.exe), and then reinstall the earlier version.

FIRMWARE CHECK

On occasion new firmware updates are included within Scratch Live software updates. After updating, run Scratch Live and click the Hardware tab in the Setup screen to see if new firmware is installable. **SEE "UPDATE FIRMWARE" ON PAGE 33.**

USING THE TOOL TIPS



Click on the ? icon to enable tool tips. Tool tips provide a handy way to learn the various features of Scratch Live. Move the mouse over a section of the screen to bring up a context-sensitive tool tip. Holding the mouse over the ? button with tool tips turned on will show you a list of all keyboard shortcuts. Tool tips are available in several languages. Scratch Live will display the

tool tips in the language that your computer is set to. If your language is not available, the tool tips will be displayed in English.

CONNECTING YOUR HARDWARE

SYSTEM OVERVIEW

The Scratch Live control records and CDs are pressed with an audible tone specifically developed for controlling Scratch Live.

The Scratch Live audio hardware converts the control signal coming from each deck into digital audio, to be sent via USB to the Scratch Live software, which decodes that signal into a stream of information based on what the DJ is doing with the control disc. A virtual 'Deck' replicates the movements of the control disc. Audio files loaded onto the Virtual Decks are then played back through the outputs of the hardware. Any manipulation of the control discs is reproduced on the audio, effectively emulating vinyl control of the files loaded in software.

CONNECTING A TTM 57SL

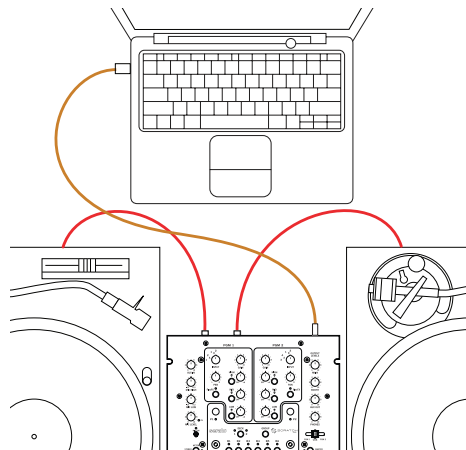

To set up the TTM 57SL for Scratch Live, using two turntables or CD players to control the software playback, follow this quick guide.

1. Connect your left deck's output cable to the PGM input 1 sockets on the rear of the mixer, and your right deck's outputs into input 3.
2. Match the L channel from each of your decks (usually white) with the white (uppermost) RCA sockets on the mixer and R (usually red) with the red sockets. This is important to give

Scratch Live the correct direction of playback. If your songs play backwards, you probably have the left and right channels swapped from your deck.

3. Set the input level dip switches for inputs 1 and 3 to LINE or PHONO to match the output level of the respective decks. (In general, PHONO for turntables, and LINE for CD players).

For example if you have one turntable connected to input 1 and a CD player connected to input

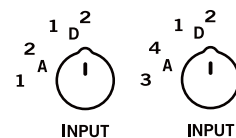

2, push dip switch 1 down into the PHONO position, and dipswitch 3 up into the LINE position. SEE "PGM INPUTS 1-4" ON PAGE 7.

4. Select Scratch Live as the audio source for the mixer by turning the input selector knobs on the top of the TTM 57SL to D1 and D2 on the PGM1 and PGM2 channels respectively.

TURNTABLE SETUP

1. Set the tone arms to the specific recommendations of the cartridge used, such that the needle never leaves the record, but not heavy enough that it heats up significantly. Both produce poor tracking.
2. Grounding is extremely important when using Scratch Live. Make sure you have good connections from the ground wires of your turntables to the grounding posts of the TTM 57SL. All DJ mixers with turntable inputs have built in grounding points for this purpose. If you do not ground your turntables properly, the control signal will be noisy and the tracking of the record position will be erratic.

CD PLAYER SETUP

Ensure the dip switch for the CD player input on the TTM 57SL is set correctly to accept a LINE level signal. **SEE "PGM INPUTS 1-4" ON PAGE 7.**

Disable all built-in effects on the CD player, including keylock/master tempo.

CALIBRATING SCRATCH LIVE

Since Scratch Live is controlled by an analog signal, there is no guarantee of what state that signal will be in by the time the software gets to interpret it. Therefore, Scratch Live needs to be able to handle a wide range of signals, and be configurable to use them optimally. Calibrating is just configuring the software to your situation. **Calibration is equally important for both vinyl and CD users of Scratch Live.**

There are two parts to the Scratch Live control signal: The directional tone, and the noise map. Listening to the control vinyl, the directional tone is the 1 kHz tone. The noise map sounds like random noise over the top of the tone.

The directional tone provides the current speed and direction of the record, while the noise map tells the software precisely where on the record the needle is currently.

THE NOISE THRESHOLD

A threshold is a lower limit, below which a process will not occur. In the case of Scratch Live, the noise threshold is the limit below which the input signal will not be interpreted as control signal; in other words if it's below the threshold, it is considered noise and ignored.

This setting is necessary because a stylus is very sensitive, and will inevitably pick up noise from the environment as well as the signal on the record, especially in the noisy environment of a live show.

HOW TO CALIBRATE SCRATCH LIVE

With music playing in the background (from any source), put your needle on record with the turntable **stopped**. If you are using CD players, the same rules apply. Have the CD deck paused or stopped while calibrating. Ensure the input level in Scratch Live is set correctly to accept a LINE level signal. **SEE "PGM INPUTS 1-4" ON PAGE 7.**

In the Setup screen, click and hold the **Estimate** button until the slider stops moving. Moving the threshold slider to the left will make Scratch Live more sensitive to slow record movement, but also more sensitive to background noise.

Repeat the process for each deck.

Things to remember:

- Your needle must be on the record.
- Your turntable (or CD player) must be stationary.
- The background music playing must be at a similar level to which you will play your set at.
- Calibrate Scratch Live every time you play.

TIP: If the slider jumps to the far right, then you have a problem with noise in your turntables/CD players/mixer. Check all your connections and make sure your equipment is well grounded. In some situations you will not be able to improve the signal quality, and you will have to play on regardless. In this situation, stick to REL mode.

THE SCOPES

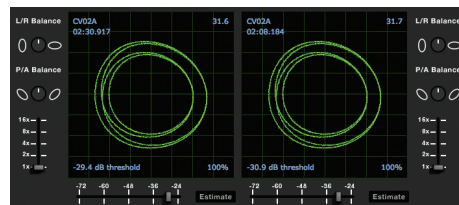

The scopes on the Setup screen display the input signal as a phase diagram. The key factors to look at on the scope display are crisp clean lines, round shape, and the tracking percentage in the lower right corner.

Start both turntables or CD players. You will see green rings appear in the scope view, **as shown above.**

For optimal performance the inner ring should be as close to circular as possible. Use the scope zoom slider (**1x to 16x**) to zoom in or out as necessary. Use the scope **L/R Balance** and **P/A Balance** controls to adjust the shape of the inner ring.

The number in the top left corner of the scope view gives the current absolute position within the control record or CD. The number in the top right corner is the current speed in RPM. In the bottom left is the current threshold setting, and the number in the bottom right shows the percentage of readable signal – this number should be close to 85% when your system is calibrated properly.

CALIBRATION TROUBLESHOOTING

After calibration, the number in the upper right corner of the scope view should say 0.0 while the needle is on the record and the turntable is stopped.

If that number is fluctuating then manually move the Estimate slider to the right until that number is stable at 0.0. If you've moved the slider all the way to -24 and it's still fluctuating then you have a grounding or interference problem somewhere in the chain.

If so, the first thing to check is that the grounding wire coming from your turntable is connected to a TTM 57SL grounding post.

Next, make sure that your mixer isn't sitting next to a power source such as a power strip or power box and that your RCA cables aren't lying across other power conducting cables.

If you are still experiencing issues, you might have to adjust the placement of your setup. For example, make sure bass bins aren't directly under the turntables.

If you have trouble getting the rings circular, you probably need to clean or change your needles.

If the image appears as a line, then you have a missing channel. Check your RCA connections and needles. **SEE "SCOPE READING AND FIXES" ON PAGE 52.**

IMPORTING AND PLAYING MUSIC

IMPORTING YOUR MUSIC

The easiest way to load music into your library is by using the **Files** button:

1. Click on the Files button to open the files panel. The left side of this window displays various locations on your computer hard drive (and external drives if you have one). Click on these locations to navigate your computer and find your music. By default, your music will usually be found in either “Music” (Mac) or “My Music” (Windows).

2. Once you have located your music, drag the folder or files you want to import onto the purple “* All...” icon. This is located to the left of your screen at the top of the crates and playlist window. If you wish to import all of your music, just drag your whole music folder onto this icon.

TIP: You can also import by dragging files and folders directly from Windows Explorer (PC version) or Finder (Mac version) into the Scratch Live library.

TIP: Adjust the size of the Files window by clicking and dragging near the three dots up or down. The vertical crates window adjusts left and right.

SUPPORTED FILE TYPES

Scratch Live supports fixed and variable bit rate .MP3, Ogg Vorbis, .AAC, .AIFF, .ALAC, .WAV and Whitelabel (wl.mp3) file types. M3U playlists are also supported. For more on Whitelabel.net audio files, **SEE “WHITELABEL.NET” ON PAGE 14.**

NOTE: iTunes Music Store DRM files cannot be played back by Scratch Live. iTunes Plus files are DRM-free.

PLAYING MUSIC

Click on the “* All...” icon to show all the tracks in your library. Use the keyboard shortcut Shift + Left Arrow to load the highlighted track on to the Left Deck, and Shift + Right Arrow to load the highlighted track on to the Right Deck.

TIP: You can also load tracks to Virtual Decks using the mouse. Click and drag a track from the track list area on to either Deck.

To start playing a track, simply put the needle on the record and start the turntable. The track will start playing as soon as it detects the signal from the control vinyl (or CD).

In ABS mode, the track will play from the position dictated by the placement of the needle on the record. If you place the needle at the beginning of the record, the track will start playing from the beginning. You can skip through the track by picking up the needle and placing it further into the record, just as with regular records (this is known as needle dropping). **SEE “SCRATCH LIVE MODES” ON PAGE 19.**

TRACK DISPLAY

When a track is loaded, the track name, artist and length are displayed in the track title bar, and the Virtual Deck shows a solid black line.

If the track has BPM or key information written in the tag this will also be displayed. **SEE “SET AUTO-BPM” ON PAGE 14.**



WHITELABEL.NET

The Serato Whitelabel Delivery Network is a unique system that allows record labels to digitally deliver promotional releases directly to DJs.

To download Whitelabel audio files and to sign up to receive updates on the latest promotional releases, visit www.whitelabel.net.

WHITELABEL AUDIO FILES

Whitelabel.net audio files are a unique format (file extension wl.mp3) developed by Serato. They are specially prepared for use in Scratch Live; pre-analyzed, tagged with song and artist info, BPM and album art where possible.

Whitelabel audio files play as high quality 320 kbps stereo audio in Scratch Live when Rane Scratch Live hardware is connected. Without Scratch Live hardware connected, or when playing these files through other mp3 software and devices, they will play as low quality 32 kbps mono audio.

Whitelabel audio files are promotional releases from records labels available to Scratch Live DJs for free from Whitelabel.net.

PREPARING YOUR FILES

ANALYZING FILES

Before you play your music in Scratch Live, It is important to first analyze your files.

The analyze files function processes the songs in your library to detect file corruption, saves the waveform overview to an ID3 tag*, and calculates auto-gain and BPM values.

HOW TO ANALYZE FILES

To analyze files start Scratch Live with the TTM 57SL disconnected. On the left side of the main screen, click the **Analyze Files** button to automatically build the overviews for all the tracks in your library.

TIP: You can drag and drop individual folders, crates or files onto this button to force the building of overviews at any time.

ABOUT CORRUPT FILES

If Scratch Live detects a corrupt file it will tag it with a corrupt file icon:



It is very important that you delete ANY corrupt files from your library as they can cause Scratch Live to crash regardless if you play the file or not. **SEE "STATUS ICONS" ON PAGE 30 AND "CORRUPT FILE DESCRIPTIONS AND DIAGNOSES" ON PAGE 51.**

SET AUTO-BPM

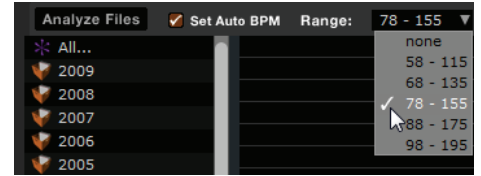

If this option is checked while analyzing files, Scratch Live will calculate the estimated tempos of your files. If Scratch Live is confident that the auto-BPM estimate for a file is accurate, it will be written to an ID3 tag* in the file. The auto-BPM function will not be applied if the track already contains BPM information. To re-analyze these files and use auto-BPM or auto gain on them, drag them onto the Analyze Files button. If you know your files BPM will fall within a certain range, use the range drop down to avoid double or half value BPMs being calculated.

***ID3 tags contain data about your tracks and are saved inside the files themselves. Genre, track name and artist are examples of common tag information. SEE "EDITING ID3 TAGS" ON PAGE 30.**

THE OFFLINE PLAYER

The offline player is a useful tool for preparing crates, auditioning tracks, and setting cue and loop points. The offline player is available when Scratch Live hardware is not connected, and outputs through the current default audio device. Load a track to the offline player by dragging and dropping onto the deck, or pressing shift + left arrow. If the end of the loaded track is reached, the next track in the current playlist is played automatically. Click the Offline Player Controls button (outlined below) to expand and hide the offline player controls.

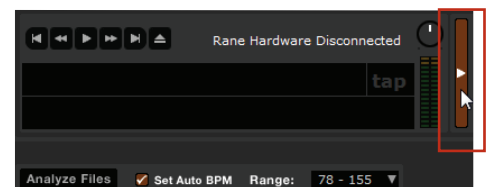

For information on rescanning, moving, copying, deleting and backing up your files, **SEE "FILE MANAGEMENT" ON PAGE 31.**

PLAYBACK CONTROL

THE CONTROL RECORD

The control record has two sides. The first side is 10 minutes long and contains the Vinyl Scroll section. The second side is 15 minutes long. Scratch Live can be configured to work with records playing at either 33 RPM or 45 RPM, depending on your preference. The record has thin marks every minute, and a thicker mark every 5 minutes (when playing at 33 RPM). These marks are to assist you when using needle dropping to move through the track. These marks do not affect the playback of the track.

The mode will switch when it reaches the end of the record so your track won't stop.

SEE "ABSOLUTE MODE" ON PAGE 19.



THE CONTROL CD

The control CD has two tracks. The first track is 15 minutes long and controls playback. The second track is 40 seconds long and controls vinyl scroll.



VINYL SCROLL

Vinyl Scroll allows you to select and load tracks using only your turntables (or CD player) – no contact with the computer necessary! To use Vinyl Scroll with turntables, lift the needle off the record and drop it into special “bonus track” section at the end of the record’s A side. The movement of the control disk now controls the selected track within your library. Lift the needle out of the Vinyl Scroll section of the record and into the lead out (between the Vinyl Scroll area and the end of the record) to change crates or iTunes playlists. Go back to the Vinyl Scroll area of the record to choose a track within the crate or playlist. Once you have found the track you wish to play, put the needle back at the beginning of the record and it will load automatically. This feature is available to CD users. Go to track 2 on the control CD to access Vinyl Scroll. Find the track you want to load, and go back to track 1.

The track you selected will be loaded and ready to play. You can reverse the direction of Vinyl Scroll and set the sensitivity in the Setup screen.

TIP: You can also use Vinyl Scroll in the Prepare window. SEE THE OPTIONS FOR “VINYL CONTROL” ON PAGE 35.

MAIN SCREEN OVERVIEW

VIRTUAL DECK

Virtual Deck shows everything about the speed and position of a track. As the vinyl rotates, so does the line on the label. The circular progress bar

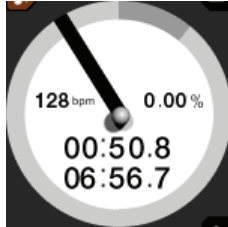

around the edge is a visual representation of the position within the song, and can be set to flash to warn you that the track is nearing its end. The time and remaining time are displayed in minutes and seconds. The pitched BPM (BPM with pitch adjustment multiplier added) is shown on the left of the Virtual Deck, and the turntable speed as a percentage pitch shift is shown on the right of the Virtual Deck. If the track has no BPM information, pitched BPM will not be shown.

If you are playing regular vinyl, notice that the Virtual Deck behaves strangely as Scratch Live attempts to decode the incoming signal. This will not cause any problems, but you may find it distracting. You can unload the currently loaded track using the eject button next to each Virtual Deck.

TIP: Use the keyboard shortcut shift-alt-arrow to unload a track from the Virtual Deck.

VISUAL AIDS

When the track is playing several waveforms are displayed. Each shows a different aspect of the track being played.

TEMPO MATCHING DISPLAY



The Tempo Matching display area provides a helpful tool for beat matching. Scratch Live detects the beats within the track, and places a row of orange peaks (for the track on the left side) above a row of blue peaks (for the track on the right side) in the Tempo Matching display. When the two tracks are matched to the same tempo, the peaks will line up. Note that the tempo display is aligned with the beginning of the bar, so the peaks keep their relative position as the track plays. This display does not show the relative timing of the beats, only the track tempos. The peaks still line up when the tracks are at the same tempo, but are out of sync.

TRACK OVERVIEW DISPLAY

This view provides a complete overview of the track waveform, including a marker to show the current position within the track. This view is useful for finding transitions within the track. The waveform is colored according to the sound: red representing low frequency bass sounds, green representing mid frequency sounds and blue representing high frequency treble sounds.

You can jump to different positions within the track by clicking on the Track Overview display (disabled in ABS mode). Grey lines behind the overview show the length of the track: a thin grey line every minute, and a thick grey line every 5 minutes. The overview will be filled when you load the track onto a Virtual Deck. On slower computers, you should disable **Autofill overviews** in the Setup screen – with this setting disabled, the overview will be filled as you play the track. **SEE “PREPARING YOUR FILES” ON PAGE 14 AND “AUTOFILL OVERVIEWS” ON PAGE 36.**

MAIN WAVEFORM DISPLAY

This view provides a close-up of the track, including color coding to show the frequency of the sound; red representing low frequency bass sounds, green representing mid-frequency sounds and blue representing high-frequency treble sounds. You can also switch to a three-band spectrum view by holding the ctrl key and clicking on the waveform. Click on the waveform to ‘scrub’ or make fine adjustments to your position within the track. This applies to INT mode only, and may be useful if you wish to set cue points in your tracks without your turntables or CD players connected. The Main Waveform is zoomed around the current position in the track. **SEE “CUE POINTS” ON PAGE 21 AND “SCRATCH LIVE MODES” ON PAGE 19.**

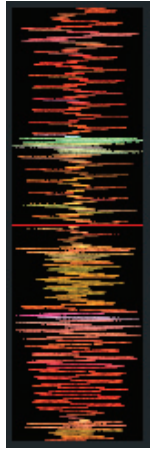

TIP: Use the + and – keys to zoom in and out.
TIP: Waveform can be either vertical or horizontal.
SEE “DISPLAY MODES” ON PAGE 18.

Kick Drum

In this example, the red part of the wave represents a kick drum, while the purple part represents a snare drum.

Snare Drum



BEAT MATCHING DISPLAY

This view shows the position of beats within the track. When beat matching, this helps align the downbeats of the two tracks. The markers are matched when the two tracks are beat matched.

Example: The following is a demonstration of using the visual aids to help beat match. In this example, the track that is playing is on the Left Deck, and the track to be mixed in is on the Right Deck.



1. Start the track playing on the Right Deck. After a few seconds, blue peaks appear in the Tempo Matching display.

2. Adjust the pitch of the right turntable until the blue peaks sit under the orange peaks in the Tempo Matching display. Once they are aligned, the two tracks have the same tempo.

3. Next align the markers in the Beat Matching display. Watch the color of the items passing by in the Main Waveform display. Remember that a kick or bass drum will be red in color, and a snare drum will be green or blue. This technique will by no means guarantee perfect mixes, but may help to speed up the process of beat matching.

MASTER GAIN

The master output of Scratch Live can be controlled using the master gain control at the top of the screen. This adjusts the output volume of all tracks played.

NOTE: For best results, set the master gain to the 12 o'clock position, and adjust the volume of individual tracks using the track gain adjustment. SEE "TRACK GAIN" ON PAGE 17.

33 / 45 SPEEDS

Set this to match the speed of your turntable for normal playback.

TRACKING INDICATOR

The tracking indicators on the main screen show the quality of the signal coming from the control record or CD. The length of the bar indicates the speed of the record or CD. The color indicates the amount of position information Scratch Live is receiving. When you are playing the record at normal speed, the tracking indicator should be grey. If it is mostly red there is a problem reading the control signal. Make sure your needles are clean, and check the calibration in the Setup screen.

NOTE: It is normal for the tracking indicator to be red when cueing or scratching.

TAP TEMPO

For tracks with no BPM information, there is a tap tempo button displayed where the BPM usually is, in the song info area. Pressing alt-space bar activates the tempo tapper (press alt-space bar a second time to activate the tempo tapper on the right Virtual Deck). Tap the space bar along with the beat. After you've tapped the first beat, you can switch to double time tapping, half time, start of each bar etc. The range is set by the first two taps, after that you can switch to any steady rhythm you feel comfortable with – quarter notes, half note, whole notes. Esc resets the BPM, Enter saves the BPM to the track. You can use the mouse if you prefer. Your CD player or turntable's pitch slider doesn't need to be at zero, we do the math for you. You can also use the tempo tapper when no song is loaded, for finding the BPM of regular records, for example.

KEY LOCK

When Key Lock is on, the key or pitch of the song stays locked at what it would be if the track was playing at normal speed, regardless of the platter speed of the turntable or CD player. Key Lock has scratch detection, so that it automatically turns off when scratching for a natural scratching sound. Turn Key Lock on or off by pressing the button to the top right of the Virtual Deck.

TIP: F5 and F10 will turn Key Lock on and off for the left and right Decks respectively.

REPEAT

Use the repeat function to repeat the song across the entire length of the control record.

TIP: Short "loop" samples can be turned into a continuous track using the repeat function. The loops must be less than 10 seconds long, and cut at the start and end of a bar.

CENSOR

Use the censor button to 'mask' parts of a song, or use as a special effect. When you press the censor button, the track starts playing backwards from that point. When you release the censor button, the track plays forward from the point you would have been, had you not pressed the censor button. Censor is available only in REL and INT modes.

EJECT

This ejects the track playing or loaded track from the Virtual Deck.

AUTOPLAY

Click the **Auto** button to enable autoplay. With this setting turned on, when one track finishes playing, the next track starts automatically. Load from a crate to play through the songs in that crate, or from your library to play through your library. Autoplay works in both REL and INT modes. **Play from start** must be checked in the Playback tab of the Setup screen for autoplay to work correctly.

REVERSE INPUT CONTROL

Swaps the Program 1 input with the Program 2 input of the TTM 57SL.

This transfers control over to the alternate Virtual Deck. For example, the physical record on the right hand side now controls the left hand side virtual deck. This essentially lets you continue mixing, but just using one turntable. **SEE "MIXING WITH ONE TURNTABLE OR CD PLAYER" ON PAGE 33.**

TRACK GAIN

Use the track gain adjustment to balance the volume of the tracks in your library. Any adjustment made to the gain of a track is saved with the file, and will be reapplied to the entire track when it is loaded again. The level meter shows the level sent to the TTM 57SL after both individual track gain and master gain adjustment. For automatic gain setting of your tracks, **SEE "USE AUTO GAIN" ON PAGE 35.**

USB DROPOUT INDICATOR

The USB dropout indicator on the main screen is a useful trouble shooting

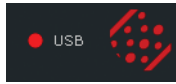

tool if you have problems with audio dropouts. Such dropouts are caused by an interruption in passing the audio to the Scratch Live hardware interface. If such an interruption (or dropout) occurs, a red light will appear briefly, just to the left of the Scratch Live logo at the top of the screen. The light will be red for one second, and then orange for four seconds.

If you do experience USB drop outs:

- Increase the USB audio buffer size. **SEE “USB BUFFER SIZE (LATENCY)” ON PAGE 33.**
- Try closing other applications that are running at the same time as Scratch Live.
- Try turning off background tasks, for example, wireless networking.
- If your CPU load is very high, try decreasing the maximum screen updates. **SEE “MAXIMUM SCREEN UPDATES” ON PAGE 37.**

DISPLAY MODES

Scratch Live gives you the option of four different display modes to suit your style of performance. The Display Mode buttons are located in the top left of the Main Screen. The available display modes are:

Library Mode: Maximizes your library space by minimizing the Virtual Deck information displayed. In Library Mode only the track information, Virtual Deck, mode, track overview display and meter are displayed.

TIP: Use the space bar to toggle between Library Mode and your current display mode.

Classic Vertical Mode: The two Decks are displayed on the left and right sides of the screen with vertical waveforms in the middle.

Classic Horizontal Mode: The two Decks are displayed on the left and right sides of the screen with horizontal waveforms in the middle.

Stack Mode: The Decks are stacked on top of each other in a horizontal fashion. Stack Mode aligns the waveforms on top of each other, while maximizing waveform space. The controls for all Decks can be shown or hidden by pressing the Show Deck Controls Button on any Deck.

LIBRARY VIEWS

You can choose between four different library views which allow for visual browsing using text and album art. Select your Library View by using the buttons in the bottom left area of the main screen. The available Library Views are:

Simple List: Displays the track information in a text list. 

Album Art List: Adds an album art column to the Simple List mode. 

Album Art Grid 1: Displays the album art as a grid with the track information text to the right. 

Album Art Grid 2: Displays the album art as a grid with the track information text below. 

NOTE: Your files must have album art added for it to be displayed. SEE “ADDING ALBUM ART” ON PAGE 30.

TIP: For all views you can adjust the font size by using the Font Size slider in the Library tab on the Setup screen. For all Album Art views you can adjust the album art size using the Album Art Size slider in the same area.

SCRATCH LIVE MODES

Scratch Live has three different modes of operation. You can switch between these modes by clicking the mode buttons near the Virtual Deck.

ABSOLUTE MODE

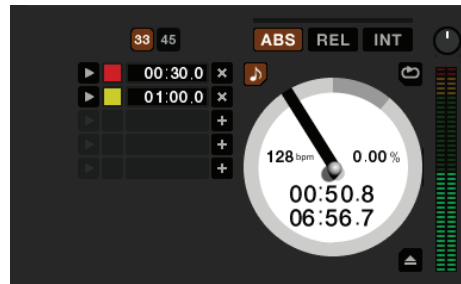

ABS mode is the default mode, and most closely resembles the properties of normal vinyl. The beginning of the track is mapped to the start of the record, and by picking up the tone arm and moving the needle to another part of the record (needle dropping) you can move to a different position within the track.

ABS mode faithfully reproduces the movement of vinyl control records, including stops, starts, scratching, needle dropping, rubbing and other turntablist techniques.

When you reach the end of the record using either REL or ABS modes, Scratch Live automatically switches to INT mode. This is known as Emergency Internal mode, and prevents long tracks from stopping when you run out of record. You can switch from Emergency Internal mode to ABS mode by lifting the needle and placing it in the lead-in of the control record. Emergency Internal mode will activate after 1 second. Use the keyboard shortcut F1 (left deck) or F6 (right deck) to switch to ABS mode.

NOTE: Be careful when scratching near the end of the record not to accidentally go past this point and into internal mode, or the track will no longer respond to record movement!

RELATIVE MODE

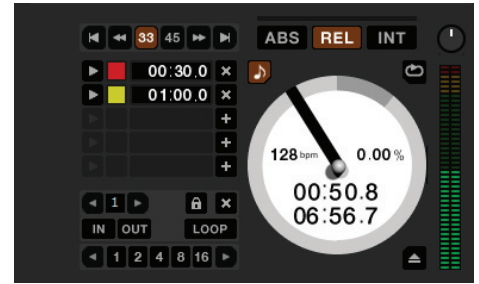



REL mode observes the relative forward and backward movement of the record, but does not take into account the position within the record. REL mode disables needle dropping, but allows skip-free scratching.

SEE “DROP TO ABSOLUTE POSITION” ON PAGE 35.

REL mode adds additional speed controls:

Previous track – Go to the previous track in the list. 

Rewind - The rewind function speeds up the longer you press the button. 

Fast forward – The fast forward function speeds up the longer you hold the button. 

Next track – Jump to the next track in the list. 

TIP: Use the keyboard shortcut F2 (Left Deck) or F7 (Right Deck) to switch to REL mode.

INTERNAL MODE

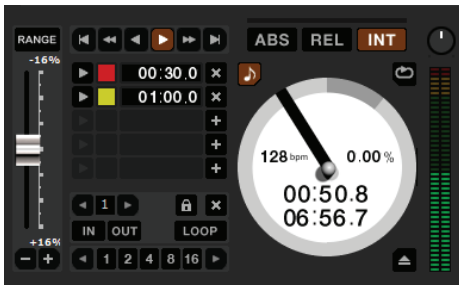

INT mode allows playing tracks without external vinyl (or CD) control. INT mode has a start / stop function and a virtual pitch slider. Holding down the shift key moves the pitch slider slowly. Holding the ctrl key and clicking on the pitch slider resets the pitch to zero.

Scratch Live automatically switches to INT mode when the end of the control record is reached; you can switch back to REL mode by placing the needle in the first five minutes of the control record. If you switch from ABS or REL into INT mode, Scratch Live automatically adjusts pitch to maintain playback speed as set by the turntable. Use the keyboard shortcut F3 (left deck) or F8 (right deck) to switch to INT mode.

INT mode adds these additional controls:

Play / pause reverse - Press to play, press again to stop playback. You can adjust the braking knob in the setup screen to range from an immediate stop to a slow turntable-style 'power down'. **SEE "BRAKING (INTERNAL MODE)" ON PAGE 35.**

Play / pause forward - Press to play, press again to stop playback. Uses the same braking as described above.

Bend down - Create a temporary decrease in the playback speed. Use bend down if the two tracks are in time, but this track is slightly ahead of the other track.

Bend up - Create a temporary increase in the playback speed. Use bend up if the two tracks are in time, but this track is slightly behind the other track.

Pitch Slider - Use the pitch slider to make pitch adjustments while using INT mode. Drag the pitch slider with the mouse to make large pitch movements, or hold the shift key and drag the pitch slider to make fine adjustments.

Clicking the **RANGE** button above the slider changes the slider range to $\pm 8\%$, $\pm 10\%$, $\pm 16\%$, $\pm 50\%$ or $\pm 100\%$.



TEMPORARY CUE

There is a temporary cue point that can be used like the Cue button on many DJ CD players. Press ctrl-I to set this temporary cue point on the Left Deck, and ctrl-K to set it on the Right Deck. This temp cue point is shown in the main waveform as a white marker. This cue point is not saved with the track, and by default is set to the beginning of the track. Press I to jump to this temporary cue point on the left deck, and K for the right deck. If you hold down the I or K key while the track is stopped, it will play from the temp cue point. As soon as you release the key, it will jump back to the temp cue point. Note that you can use this shortcut to jump to the beginning of the track if the temporary cue point has not been set. **SEE "CUE POINTS" ON PAGE 21.**

MORE CONTROLS

You can also control playback using the computer keyboard shortcuts — turn Caps Lock on to enable. **SEE "PLAYBACK KEYS USE SHIFT" ON PAGE 34.**

Left Deck	Function	Right Deck
Q	play / pause reverse	A
W	play / pause forward	S
E	pitch down	D
R	pitch up	F
T	bend down	G
Y	bend up	H
Alt-Q	load previous track	Alt-A
Alt-W	load next track	Alt-S
Alt-E	rewind	Alt-D
Alt-R	fast forward	Alt-F
Ctrl-I	set temporary cue point	Ctrl-K

Click on the waveform to 'scrub' or make fine adjustments to your position within the track. This may be useful if you wish to set cue points in your tracks, and don't have your turntables or CD players connected.

NOTE: If you play a track in INT mode, and then switch to ABS or REL mode, the pitch adjustment will be dictated by the turntable, so there will be a jump in pitch unless they are already perfectly matched.

TIP: If you are in ABS or REL mode and you get a build up of dust on the needle that is breaking up the audio, hold down ctrl and press the INT button. This will take you to Internal mode and reset the pitch to zero.

CUE POINTS

Use cue points in Scratch Live to mark and trigger different parts of your tracks. The cue point markers are saved with the file in the track's ID3 tag. This means they will be present each time you load the track.

SETTING CUE POINTS

You can set up to five cue points for each track. Click on the + button to place a cue point, or use the keyboard shortcuts below. A cue point will be set at the current playhead position of the track and can occupy any of the 5 slots.

Use the keyboard shortcuts: ctrl-comma (for left) and ctrl-period (for right) to place cue points in chronological order. Alternatively, use ctrl-1 through 0 to set a specific cue point, i.e., to set a cue point on the Left Deck in slot two, press ctrl-2.

Notice that the stripe on the Virtual Deck jumps to the 12 o'clock position and changes color when you set a cue point – you are at the cue point when the stripe is one solid color and at the 12 o'clock position. As the track plays on beyond the position of the cue point, the colored bar shortens by a fifth for each rotation. Likewise, as you approach the cue point, the color will grow by a fifth each rotation. For example, the picture below shows the track just before the end of the 5th rotation before the cue point.



TIP: Zoom in on the waveform using the – and + keys and ‘scrub’ to the desired position for greater accuracy when setting cue points.

ENABLE HOT CUES

To turn on hot cues, check **Enable hot cues** in the Playback tab on the Setup screen. When hot cues are enabled, you can set cue points simply by pressing the number keys 1 through 0 (no ctrl modifier required). Note that you can only add cues this way if the cue point slots are empty.

SEE “ENABLE HOT CUES” ON PAGE 21.

TRIGGERING CUE POINTS

Click the arrow to the left of each cue point to jump to it (REL and INT mode only). You can also jump to cue points using keyboard shortcuts – 1 through 5 for the cue points on the Left Deck, and 6 through 0 for the Right Deck cue points.

EDITING CUE POINTS

To remove a cue point, use the x button on the right side of the cue point panel. You can also over-write cue points by using the shortcut keys ctrl-1 through 0.

CUSTOMIZING CUE POINTS

The colors of cue points can be changed at any time. To change the color of a cue point, click on the colored square and choose a new color from the drop down menu.

You can also drag and drop cue points to change their order in the list. If you wish to have the cue points sorted chronologically, check **Sort cues chronologically** in the Playback tab on the Setup screen. If you load the same track onto both Decks, you will be able to add or modify cue points from either Deck.

When you jump to a cue point in INT mode while paused, the track will play from the cue point for as long as the key or mouse button is pressed, after which the playhead returns to the cue point. If this is done using the keyboard while the track is playing in either INT or REL mode, the cue point will be repeatedly triggered, producing a stuttering effect.

LOOPING

You can save up to 9 loops per track; these loops are saved in the



file, and will be present when you reload the track. To make a loop, set the in-point by clicking the **IN** button, and the out-point by clicking the **OUT** button. To turn the loop on or off, click the **LOOP** button. If you want the playhead to jump to the start of the loop when you enable the loop, hold the control key and press the **LOOP** button.

To adjust the in-point of the loop, click the **IN** button. You can use the arrow keys: left arrow to move the in-point towards the start of the track, right arrow to move the in-point towards the end of the track. Hold down the shift key while pressing the arrow key to make coarse adjustments. Click the **IN** button again to save the in-point. The same applies to adjusting the out-point.

You can also use the control vinyl (or CD) to adjust the in- and out-point. Click the **IN** button, then move the control vinyl. Moving the vinyl will adjust the in-point. Once you are happy with the new in-point, click the **IN** button to save, and release the control vinyl.

The control vinyl will go back to controlling playback once the record is back up to normal speed. Using the control vinyl to adjust loop end points is optional – to turn this feature off, disable the **Adjust loops with vinyl** option in the Playback tab of the Setup screen. There are 9 available loop slots per track. If a loop is set in a given slot, the background (behind the loop number) will be green. Press the x button to clear the loop. If you click on the locked loop symbol,

a red border will appear. This indicates the loop is locked, and you will not be able to adjust the end points or delete the loop until you unlock it, by clicking on the number again.

NOTE: Looping applies to REL and INT modes.

AUTO LOOPING

Auto looping allows you to create loops instantly. If the track has a BPM value simply click the number of beats you wish to loop and Scratch Live will create the loop for you. The loop is snapped to the beats in the song detected by Scratch Live so even if you press the button slightly out of time Scratch Live will still create a perfect loop for you.

Five auto-loop buttons are available on screen at any one time. They range from 1/32 to 32 beats. The user can select the auto loop range with the ◀ and ▶ buttons.

Pressing an auto-loop button will create a loop start point from the nearest beat to the playhead (within reason), and set a loop endpoint in the future. Pressing auto-loop 1 while auto-loop 1 is active will deactivate the loop. Pressing a different auto-loop button while looping is active will extend the endpoint of the current loop to the appropriate new auto-loop length.

You can also save an auto-loop to the next available slot. When using an auto-loop, a  save button is visible where the lock loop button normally is.

NOTE: Auto-looping requires the track BPM to be set. SEE “SET AUTO-BPM” ON PAGE 14.



THE A - SLOT

A special loop slot ‘A’ exists for auto-looping. The act of using the auto-loop buttons sets a loop in the ‘A’ slot, following the rules above. Turning a loop off using the auto-loop buttons returns you to the loop slot that you were previously in at the time you started auto-looping. Turning the loop off using the ‘loop’ button leaves you in the ‘A’ slot. The ‘A’ slot is not saved to disk automatically, pressing ‘save’ saves the loop to the first empty slot in 1-9.

Auto-looping shortcut keys are alt-1 to 5 for the left deck, and alt-6 to 0 for the right deck. They correspond to the looping buttons as laid out on screen. ie. if the onscreen buttons display 1 2 4 8 16 bar loops, alt-1 triggers 1 bar loop, and alt-5 triggers a 16 bar loop.

LOOP ROLL

Loop roll performs a standard auto-loop, but when the loop is turned off, the playback position is returned to the position where it would be if it had not entered the loop (much like censor).

The other difference between loop roll and standard autoloop is the ‘roll’ button is momentary. The loop is engaged when the button is pressed down, and disengaged when the button is released. Use short loop lengths to create “stutter” type effects.

To activate loop roll, hold control + alt while clicking on the desired autoloop increment, or use the **keyboard shortcuts:** control + alt + 1 through 5 for the Left Deck and control + alt + 6 through 0 for the Right Deck. (ie. the same as the autoloop controls with the additional ‘alt’ key as a modifier).

The range of values available for loop roll are 1/32 through to 32 beats. The shortcut keys will activate whichever loop lengths are visible on screen, i.e., if you have lengths of a 1/4 beat through to 4 beats visible for the Left Deck, control + alt + 1 will activate a 1/4 beat loop roll, control + alt + 2 will activate a 1/8 beat loop roll and so on.

Use the ◀ and ▶ buttons to toggle through the range of possible lengths visible on screen.

LOOP ROLL WITH MIDI

You can assign loop roll to MIDI in several ways: After pressing the **MIDI** assign button in Scratch Live, press the control + alt keys, click on an auto-loop value, then click on the button/slider you want it mapped to on your MIDI controller. Alternatively, you can assign the singular loop roll button to MIDI, then assign a MIDI knob or slider on your controller to the autoloop select knob (visible in the MIDI assign panel area when in MIDI assign mode) to change the values on the fly.

TIP: When you have the “Autoloop Select” knob assigned to MIDI, you have all of the loop roll lengths at your disposal. This allows you to roll up and down the loop length scale, to create interesting stutter and build-up effects.

NOTE: Like autoloop, loop roll requires a BPM value written to the ID3 tag in order to work. Build overviews with the “Set Auto BPM” box checked and the proper range for your music selected to ensure an accurate BPM value.

SP-6 SAMPLE PLAYER



The SP-6 Sample Player allows you to play up to six sources of audio, in addition to the tracks playing on the Virtual Decks. Any audio file in your Scratch Live library can be loaded to any one of the six slots, allowing playback of short samples, sound effects, or full length tracks.

The SP-6 is enabled when the TTM 57SL is plugged in, but not operational in the offline player mode.

Click on the **SP-6** button to access the SP-6 window. In the top right corner of the SP-6 there is a button which opens the Display Menu. Clicking on this drops down a menu with the list of available controls:

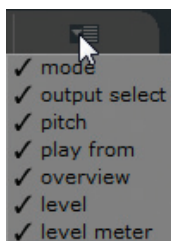

- **Mode** - Chooses the play mode - Trigger / On-Off / Hold / Repeat modes.
- **Output Select** - Assigns individual slot outputs to the left, mix, right or to the master output selector.
- **Pitch** - Pitch Slider / Bend / Nudge / Keylock controls.
- **Play from** - Choose which cue point / loop to use for the loaded track.
- **Overview** - Displays the overview of each track.
- **Level** - Individual sample slot level and Gain controls.
- **Level meter** - Displays the volume level for the sample slot.

This enables you to set up the sample player with the appropriate controls that suit your workflow.

LOADING THE SP-6

To load a track to the SP-6, drag and drop the desired file from your library into one of the sample slots. To eject a track, click on the eject button to the right of the title display.

TIP: You can load tracks to the SP-6 with the keyboard shortcuts: ctrl + alt + z to n.

TIP: Select and drag six tracks from your library onto the first sample player slot to simultaneously load six tracks across all six slots.

TIP: If you don't wish to use the SP-6, you can disable it in the Plugins tab on the Setup screen.

PLAYING SAMPLES

Pressing the play button on each slot will play the loaded audio. 

TIP: Use the shortcut keys

z (slot 1) x (slot 2) c (slot 3)
v (slot 4) b (slot 5) n (slot 6)

to trigger each sample respectively.

SP-6 INSTANT DOUBLES

You can instant double from the Virtual Decks down to the SP-6, from the SP-6 up to the Virtual Decks and also between the sample slots themselves. This means the position, track gain and speed will match when you drag a track to from one location into another. This allows you to beat match tracks with your turntables/CD players on the Virtual Decks, and then “instant

double” the track down to a slot, freeing up the Virtual Decks to continue your mix with other tracks. Click and drag an already playing track from a Virtual Deck or sample slot and drop it on another sample slot to begin instant doubling.

SP-6 PLAY MODES

Each sample slot has three different play modes:

Trigger mode - When play is pressed,  the audio plays through until the end of the track. Pressing repetitively will trigger the audio from the beginning of the track. To stop the audio, hold the alt key while either clicking the play button, or pressing the corresponding shortcut key (e.g., alt - z for slot one).

Hold Mode - The sample will only play  while you press and hold the play button or the corresponding shortcut key. Upon release of the play button, the audio stops immediately. This mode most closely resembles the function of the “note off” mode found on many popular samplers.

On / Off Mode - When play is pressed,  the audio plays through until the end of the track. Pressing play again stops the audio.

Repeat Mode - Each slot has a repeat  button. When activated, this will repeat the loaded audio file from beginning to end, or will turn on the loop selected in the “play from” field.

TIP: Short “loop” samples can be turned into a continuous track using the repeat function. Ensure there is a clean cut at the start and end of a bar.

SP-6 PITCH CONTROLS

There are individual Pitch Slider, Bend, Nudge, and Keylock controls for each sample slot. The BPM is also displayed next to the pitch slider. If no BPM is present in the tracks ID3 tag, the pitch of the track is displayed as a percentage.



Click and drag the pitch slider to make regular pitch adjustments. Hold the shift key and move the pitch slider to make fine pitch adjustments.

Click on the + and – buttons to nudge the track into time. (temporary pitch adjustment) Hold the ctrl key and click on the + and – buttons to make ultra-fine pitch adjustments to nudge the track, adjusting the pitch permanently.

SP-6 ‘PLAY FROM’ SELECTOR

Use this selector to choose where the track will play from. You can choose to play a track from the start of the file, any one of the cue points, or any one of the loop in points.



When this is set to play from start, or play from a cue point, the track will play right through until stopped. When a loop is selected, the track will play until the loop out point, unless you have “track repeat” on, in which case the track will loop using the in and out points of the selected loop.

The number of options will be dependent on the number of cue points and loops already set in your track. i.e if the track loaded has no cue points and loops set, then only “start” will be available as a “Play From” option.

TIP: To set or adjust cue and loop information for a track, load it to a Virtual Deck, make your adjustments, then load it back into the sample slot.

SP-6 TRACK OVERVIEWS

Displays an overview of the track loaded to each sample slot. The waveform, play head position, cue points and selected loops will all be visible.



SP-6 SLOT VOLUMES

Each individual sample slot has a separate volume slider and gain control.



Volume Sliders - Use the volume slider to mix and make temporary adjustments to the volume of the sample you are playing. You can use these sliders like you use the line faders or up faders on your DJ mixer, fading from full volume right through to completely silent.

Gain Knobs - In addition to the volume slider there is an additional gain knob for each slot. These allow you to fine tune the maximum gain volume of the loaded sample. The gain adjustment will also be written to the track’s ID3 tag, meaning that it will be the same everytime you load it.

SP-6 OUTPUT SELECTOR

Use the output selector to choose where you wish to have the SP-6 output to.



- L** outputs through the left channel
- M** outputs through both channels (mix)
- R** outputs through the right channel

There is also a master sample player Gain knob to adjust the overall SP-6 volume.



INDIVIDUAL OUTPUT SELECTORS

By default each sample slot will be set to Master, mirroring the SP-6 master output setting. You can however, use the individual output selector buttons to override the master output setting.



To send an individual slot to a different output from the master, deselect the master option by clicking on the master button for the corresponding slot.

This will unlink the sample slot from the master sample player output selection, allowing you to choose the L, M, R output for each slot. These output routings will be saved when you close down Scratch Live, so the next time you launch Scratch Live, your preferred settings will remain the same.

SP-6 SAMPLE BANKS

The SP-6 has four separate sample banks, labeled A, B, C and D. To switch between the different banks click on the A, B, C or D buttons. Each bank will save the individual sample and sample slot settings you last used, allowing you to prepare banks for easy recall at a later stage. Sample Bank A will load as the default.



SP-6 MUTE BUTTONS

Use the mute buttons to mute the audio output for each of the SP-6’s sample slots. Click on the mute button to mute the audio output, click the mute button again to turn the audio back on.



You can also ctrl-click on the mute buttons to mute the outputs momentarily, meaning that the audio will only be muted for as long as you hold your mouse click.

TIP: You can MIDI assign these buttons, allowing you to create a virtual kill switch for the sample slot. To MIDI assign momentary mute, hold ctrl and click on the mute button before tapping your MIDI controller.

SP-6 MIDI

All features of the SP-6 are MIDI assignable. The SP-6 window must be opened first before enabling MIDI assign mode. **SEE “MIDI CONTROL” ON PAGE 26.**

DJ-FX PLUGIN

The DJ-FX Plugin gives you control of two FX units, each with three chained effects slots per unit. Each FX unit has two control modes: Ultra Knob Mode and Super Knob Mode, both of which can be fully customized. The DJ-FX plugin opens in Ultra Knob Mode by default.

To enable the DJ-FX Plugin, go to the Plugins tab in the Setup screen, choose DJ-FX and check **Enable DJ-FX Plugin**. Once enabled, the DJ-FX panel button appears in the panels area on the main screen.

NOTE: The DJ-FX plugin is not visible if your Rane hardware is not connected.

ULTRA KNOB MODE

Click the Ultra Knob Mode button to select Ultra Knob Mode. This allows you to control up to three effects slots in one FX unit using the one Ultra Knob.

Click on the drop down menu to load an Ultra Knob effect. (This is “empty” before settings are saved in Macro Edit Mode.)

Click the **ON** button to enable the effect, and use the Ultra Knob to control the wet and dry amount of all effects.

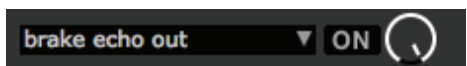

Click the Show Parameters button to show the effects and parameters that are controlled by the loaded Ultra Knob preset.

SUPER KNOB MODE

Super Knob Mode allows you individual control of each effect in the FX unit. Each effect slot has a Super Knob which controls the wet and dry amount for the effect.

Click the Effects drop down box to select an effect for the effect slot. You can leave a slot empty by selecting “empty.”

Click the **ON** button by the Super Knobs to toggle turning the effect(s) on and off.

The effects chain works in series going from effects slots 1 to 3, meaning that the effected audio from slot 1 passes through slot 2, which is then passed through slot 3.

EFFECTS BPM MULTIPLIER

The Effects BPM Multiplier is used to adjust the effect time. The effect time is set using the track’s BPM value, but by applying the Effects BPM Multiplier you can increase or decrease the effect time.

DECK ASSIGN

You can select which Deck the FX unit applies to by clicking the **Deck** buttons. Each Deck can only pass through one FX unit at a time.

SHOW PARAMETERS

Press the Show Parameters button to expose the individual parameters for each effect. You can then control the individual parameters by adjusting their respective knobs.

In Ultra Knob Mode, use this to select which effects are loaded and controlled by the Ultra Knob.

In Ultra and Super Knob Mode, you can link or unlink a parameter to the Super Knob by pressing the Link Button, allowing one master control of some parameters and individual control of others.

MACRO EDIT MODE

Macro Edit Mode is an advanced option that allows you to create macro mappings for each effect and to save any effects edits made in Ultra or Super Knob Mode.

Open Macro Edit Mode by clicking the Macro Edit Button while Show Parameters is open. Once opened, more controls appear which allow you to create and change parameter mappings.

To map a parameter to the Ultra or Super Knob:

1. Unlink the parameter that you want to map to the knob. The Macro Min and Max buttons for this parameter are now displayed.
2. Move the Ultra or Super Knob to the position that you want the parameter to start mapping from.
3. Move the Parameter Knob to the position that you want the to be the lowest value of the parameter.
4. Press the Macro Min button to set the minimum position.
5. Move the Ultra or Super Knob to the position that you want the parameter to end being controlled from.
6. Move the Parameter Knob to the position that you want the to be the highest value of the parameter.
7. Press the Macro Max button to set the maximum.
8. Link the parameter to the Ultra or Super Knob by pressing the Link button.

Now when you adjust the Ultra or Super Knob you will see the parameter knob move within the range that you just specified. Any parameters not customized but linked to the Super or Ultra Knob will behave as normal.

You can save any macro mappings you have made to an effect by clicking the Save button by the Super Knob, and save effects combinations made in Ultra Knob Mode by clicking the Save button by the Ultra Knob.



MIDI CONTROL

OVERVIEW

The MIDI Control feature in Scratch Live provides the ability to map MIDI controls to Scratch Live controls, and thus control the functions of Scratch Live using MIDI controllers such as keyboards, triggers, sliders, and knobs. Integrating MIDI controllers into your Scratch Live setup can improve live performance usability, such as hitting pads on a MIDI controller to trigger loops and cue points.

MIDI CONTROLLER SETUP

The process of setting up a MIDI controller for use with Scratch Live will vary depending on the hardware in question. Many devices can connect to a computer using MIDI over USB, and will either be supported directly by your operating system, or require installation of drivers and configuration utility software. Follow the manufacturers instructions for installation.

Other controllers may solely use a MIDI out connector to send control messages, and will require a separate MIDI interface unit to communicate to software. Generally the MIDI interface will come with drivers and configuration tools which pass your controller's output onto an available MIDI channel, which can be used by Scratch Live.

Once your controller is installed and functioning correctly, use the directions for assigning controls below.

ASSIGNING CONTROLS

To enable MIDI assign mode, click the **MIDI** button. Hovering the mouse pointer over a control will bring up the MIDI assignment box, showing the current assignment status.

To assign a MIDI control, click on the control in Scratch Live, then move the MIDI control. The MIDI assignment box should update to show it has mapped the controls to one- another.

To un-assign a MIDI control, click on the control in Scratch Live, and press return on your computer keyboard.

NOTE: Once in MIDI assign mode, Scratch Live controls will no longer respond directly to the mouse. If you need to change a control using the mouse, disable MIDI assign mode.

While in MIDI assign mode, controls which have MIDI inputs assigned show a green box indicator around them.

MIDI PLATTERS

The Scratch Live Virtual Decks are not user assignable to MIDI control. MIDI devices with platters on them all send different data so user mapping is not possible. To control the platter use a natively supported controller.

ASSIGNING MIDI TO OTHER CONTROLS

Controls which are not normally visible are available for assignment when in MIDI assign mode by clicking on the **Show MIDI Panel** button. This will open up a panel allowing MIDI assignment for controls including library navigation as well as additional Deck functions such as fine pitch control and extended cue and looping features.



CTRL-CLICK FUNCTIONALITY

Some Scratch Live controls on the GUI have additional functionality assigned to ctrl-click. You can assign ctrl-click functionality to a MIDI control, alongside the normal functionality. For example, ctrl-click on the internal mode pitch slider returns pitch to zero. To assign this to MIDI control, enter MIDI assign mode, ctrl-click on the slider, and then assign one of the pads to it. When you press the pad, pitch goes to 0.

PRESETS

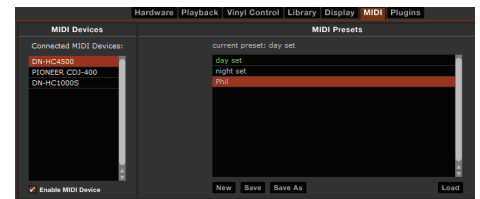

MIDI presets are accessible in the MIDI panel of the setup screen. By default, the current MIDI assignments in Scratch Live are automatically remembered and loaded next time you start the program. The Preset panel allows you to save and recall several different MIDI setups. This is useful if you are using several MIDI devices or want to quickly switch MIDI setups without having to reassign all your controls.

NATIVE CONTROLLER SUPPORT

This Scratch Live version currently has native support for the following 3rd party controllers:

- Denon DN-HC4500
- Denon DN-HD2500
- Denon DN-HC1000S
- Novation Dicer
- Numark DMC2
- Numark iCDX
- Pioneer CDJ-400
- Pioneer CDJ-900
- Pioneer CDJ-2000
- Pioneer MEP-7000 / SEP-C1
- Vestax VFX-1

These controllers are plug and play, and can automatically control Scratch Live with no MIDI assignment necessary. Visit serato.com for detailed documentation on how to use these controllers.

MIDI DEVICES

Any connected MIDI device will be listed within the MIDI Device List in the MIDI panel of the Setup screen. You are able to enable or disable any of these devices using the “Enable MIDI Device” checkbox.

TECHNICAL INFORMATION

Scratch Live MIDI Control only supports:

- Note On/Off
- Standard 7-bit CC (Control Change)
- 14-bit CC
- RPN/NRPN (14-bit).

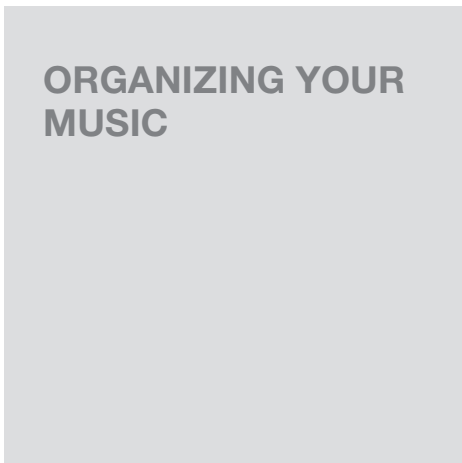

Scratch Live can support an unlimited number of tracks – the only limitation is the size of the hard drive of your computer. A number of features are included to help you to keep your music organized and find songs quickly and easily.

GROUPING TRACKS INTO CRATES

Scratch Live supports several ways of organizing and sorting your file library. iTunes™ users will notice that Scratch Live can incorporate your existing iTunes library and playlists.

Scratch Live uses digital “crates” for quick access to your favorite collections. There is no limit to the number of crates you can create, and any given track can be placed in multiple crates. For example, you could organize your files into the following crates, where any one track would be filed in more than one crate:

- Hip Hop
- UK Hip Hop
- French Hip Hop
- Inst Hip Hop
- Old Hip Hop
- Hip Hop LPs

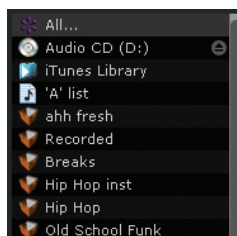

To make a new crate, click the + button under the library window. To rename a crate, double click the crate name.

You can change the order of tracks within a crate by sorting by the “#” column and dragging them up or down.

TIP: Check the protect library option in the setup screen to prevent changes to your crates. If you do delete a crate by accident, you can get it back from the recycle bin / trash. Crate files have the extension .crate.

SUBCRATES

You can drag and drop crates into other crates to make subcrates. If you drag a crate to the very left of the crate panel, it will stay in the top level of the crate structure. If you drag the crate a little to the right, onto the name of another crate, it will make the crate you are dragging a sub crate of the first crate.

SMART CRATES

Smart crates are crates which update their contents by using keywords which are matched with selected tags of your music library tracks. Smart crates can be updated automatically or at your discretion.

To create a smart crate, click the Add Smart Crate button in the bottom left corner of the main screen  (blue crate icon). A popup window will open which allows you to add the rules to fill your smart crate. Press **Add Rule** to add a rule for the smart crate to match with. For each rule you can choose a field to match on from the drop down menu:

- Added (date)
- Album
- Artist
- BPM
- Comment
- Composer
- Filename
- Genre
- Grouping
- Key
- Label
- Remixer
- Song
- Whitelabel
- Year

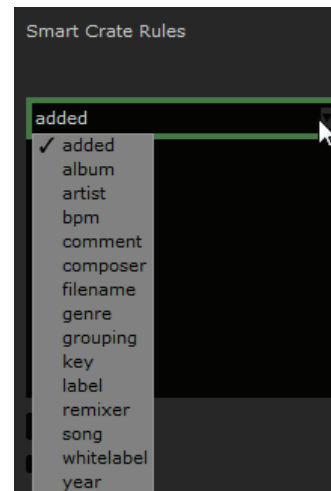

You can then choose the following inclusion / exclusion criteria:

- Contains
- Is
- Does not contain
- Is not

Check the **Match all of the following Rules** option so that tracks must match all the set rules to be added to the crate. If this option is not checked, any track which matches any of the rules will be added to the crate.

Check the **Live update** option to have the smart crate update when any tags are edited in your music library. With this option unchecked, the crate contents will be updated only when you click the refresh crate icon, which is not visible when Live update is checked.

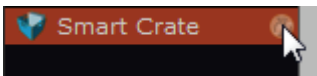

Click **Save** to save your crate or **Cancel** to exit without saving.

Click the **Edit** button (next to the Add Smart Crate button) to edit the rules of an existing Smart Crate.

SORTING YOUR FILES

The track information display area can be customized to display the columns listed below:

- Added
- Album
- Artist
- Bitrate
- BPM
- Comment
- Composer
- Filename
- Genre
- Grouping
- Key
- Label
- Length
- Location
- Remixer
- Sampling
- Size
- Track
- Video Track
- Year

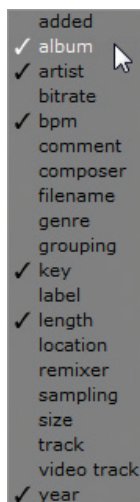

The column button ◀ is located at the top of the library pane in the right hand corner. Click on the column button to select which columns you want to display. To sort your library by a column, click the column header so it highlights. For example, clicking on the album column header will sort your library alphabetically by album title. To move a column, drag the header to the left or right. To resize a column, click on the column boundary and drag it to the left or right.

USING THE SONG BROWSER



The song browser allows you to filter your song list by Genre, BPM, Artist and Album. To turn the song browser on or off, click the browse button.

SEARCHING

Scratch Live includes a search function to help you find files quickly and easily. Enter text into the search box and Scratch Live will automatically find as you type. To select which fields the search function will look through, click on the left hand side of the search box.



The drop down menu shows which fields are currently being used. Press esc or the x button on the right of the search box to clear the search.

TIP: Use the keyboard shortcut 'ctrl-f' to jump to the search box. This keyboard shortcut will also take you out of any crate or playlist that you might be in and into your main library, so you can find any track in your collection. If you then click on a crate or playlist, the search query will be cleared.

PREPARE WINDOW

The prepare window is a holding area for tracks, much like preparing a set by lifting records part way out of your record bag. You can drag tracks (or whole crates) from the main track list into the prepare window, or simply drag them onto the prepare button. These tracks will be removed from the prepare window once they have been played. All tracks in the prepare window will be discarded when you exit Scratch Live.

TIP: Use the keyboard shortcut ctrl-p to add tracks to the prepare window.

TIP: Select the contents of the prepare window and drag them onto the new crate button (+) to save your selection as a crate.

HISTORY

The history button opens a  complete log of all the tracks you have played and allows exporting Scratch Live session information as a data file.

Each session is catalogued by date and time. Using the drop down arrow, you can navigate to and view detailed information of any previous sessions. There are columns for the period (i.e., date of session), name of track and artist name. In addition, these other categories listed below will give you more detailed information about your sessions:

Start Time - When viewing a song row, the start time of the song is displayed. When viewing a session row, the start time of the session is displayed with the date (in real time value).

End Time - When viewing a song row, the end time of the song is displayed. When viewing a session row, the end time of the session is displayed with the date (in real time value).

Playtime - When viewing a song row, the total played time of the song is displayed (i.e., 00:03:00). When viewing a session row, the total elapsed time of the session is displayed with date (i.e., 10/09/08 01:38:16).

Deck - The virtual deck the song was played on will be displayed under the deck column. In the song row, either left or right is displayed. The offline player will be listed as offline.

Notes - Use this field to list particular information about your songs and each session (i.e., note how you transitioned from one track to another).

Start Session / End Session - To start or end a session, click the corresponding button.

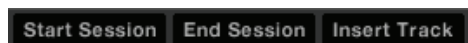

Insert Track - If you wish to add information for tracks not played in Scratch Live into your session (e.g., if you played one of your favorite vinyl or CD), select the song you want to insert after and click the Insert Track button.

Double click the inserted track fields and edit your information accordingly. (Note that when exporting an m3u playlist [see exporting below] “inserted tracks” will not be present.)

Export - You can export each session as a data file using the export button. Select a session, then choose your preferred file format, and click export. There are three possible export formats:

- **text** - to create a simple text file with your session information contained within.
- **csv** - to create a file for use in spreadsheet software.
- **m3u** - to create a playlist file, which can be imported into media players. Note that an m3u does not contain audio itself, it only points to the location of your audio files. (Inserted tracks within sessions will not be included in an m3u playlist.)

• **Serato Playlist:** see “Serato Playlists” on page 29.

Delete - To delete a history session, highlight the session, then press ctrl + del.

TIP: To make a new Scratch Live crate containing your session information, select a session and drag it to the + plus crate button. (This will automatically name the crate with the session date).

Listing Behavior - only the tracks you **actually** play are listed in history. This is done using an A-B algorithm, meaning a track on deck A is only listed once the track on deck B has been changed or ejected.

You can choose to show tracks which you have auditioned, but not actually played, by checking the show “unplayed tracks” box. The session will then also list these tracks in grey, along with actual played tracks.

Alternatively, you can mark or unmark tracks as played manually. Select a track (or a group of tracks) and click the mark played / mark unplayed button. This may be useful if you play

a track off regular vinyl or CD - breaking the A-B algorithm).

Songs that you have played are marked as green in your library. Click on the button marked ‘clear’ to reset the list of recently played tracks and turn the color of your library back to white.

SERATO PLAYLISTS

The Serato Playlists plugin allows you to upload your history sessions to your serato.com profile for viewing, sharing and editing. You can upload your playlist once your session is complete, or by using the Live Playlists feature to update your playlists online in real time!

To enable this plugin, go to the Plugins tab on the Setup screen and check the **Enable Serato Playlists Plugin** option. Open the History panel and you will now have access to the Serato Playlists options.

UPLOADING SERATO PLAYLISTS

Once you have finished your session, or to upload a previous history session, select the desired session in the History panel. Click the Format dropdown box, select **Serato Playlists** and click the **Export** button. You will receive the following warning:

Warning: This feature will submit play data from your History to your online Serato Playlists and may affect sound card performance while sending.

Do you wish to continue?

If you choose “Yes” you will then be taken to www.serato.com where you can review your playlist before choosing to post it online. Once posted, you have the option to edit the playlist and track information.

NOTE: We recommend that you turn off any wireless networking devices when using Scratch Live. If you export your playlist online whilst playing you may experience USB dropouts. If so, you may wish to avoid using this function.

LIVE PLAYLISTS

Serato Playlists has the Live Playlists option to allow you to display what you are playing online in realtime on your serato.com profile.

To enable the Live Playlists feature go to the Plugins tab on the Setup screen and check the **Enable Live Playlists** option. Once enabled, the **Start Live Playlist** button is now displayed in the History panel. Click this to start and stop your Live Playlist session.

NOTE: Live Playlists requires you to be connected to the internet while playing, which may result in USB dropouts. If so, you may wish to avoid using this function.

EDITING ID3 TAGS

Much of the information associated with each file can be edited from within Scratch Live. Double click on the attribute within the main library to edit the attribute. Filename, length, size, bit rate and sampling cannot be edited. This information is saved in the file itself. Note that the protect library option in setup must be unchecked to allow edits. **FOR DETAILS ON AUTO-BPM SEE “PREPARING YOUR FILES” ON PAGE 14.**

TIP: Use the keyboard shortcut ctrl-e to edit text. Hold down the ctrl key and move with the arrow keys to change to a different field while staying in edit mode. When you have more than one file selected, editing tags changes all the files in your selection.

TIP: The second column in the library is the label color for that file. Click it to bring up a color palette, and customize the virtual deck for that file.

LIBRARY ZOOM

You can change the size of your library text by using the shortcuts ctrl + and ctrl -.

DISPLAY ALBUM ART

MP3 files can contain album art information. Click on the show album art button at the very bottom left of the screen to open a small window. This window displays the album art of the track currently selected in the library.

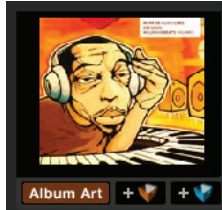





Album art can also be shown next to the track information display on each virtual deck. Click on the display tab of the setup menu to find this option. **SEE “SHOW ALBUM ART ON DECK” ON PAGE 37.**

ADDING ALBUM ART

You can add album art to a file by dragging and dropping a jpeg or png file onto the track in any of the album art views, or onto the Album Art window.

STATUS ICONS

The leftmost column shows the status of each track. The image to the left shows five tracks with differing statuses.

- Scratch Live has detected some corruption in the MP3 file. If possible, re-encode the MP3. 
- The track has been imported from the iTunes library. 
- The track has been imported from the iTunes library, and Scratch Live has detected some corruption in the MP3 file. Solution: If possible, re-encode the MP3. 
- The track cannot be found. Most likely the file has been renamed or moved. 
- Tracks that are read-only have a locked icon. 

MORE INFO ON CORRUPT FILES

If you have a corrupt file in your library, hover your mouse over the status icon for information on what type of corruption was found. **SEE “CORRUPT FILE DESCRIPTIONS AND DIAGNOSES” ON PAGE 51.**

FILE MANAGEMENT

Located in the files pane are two buttons, rescan ID3 tags, and relocate lost files. Use these tools for ongoing file and library management.



RESCAN ID3 TAGS

Click this button to force Scratch Live to re-read all file tags. Alternatively, you can drag and drop files, folders, or drives onto the rescan id3 tags button from the files pane. This will only scan the files that you drag and drop, resulting in much faster processing.

TIP: Rescanning the tags is a handy way to identify all the files that Scratch Live can't find (for example if the files have been altered or moved). These tracks will show up red in the main track list, with an exclamation mark in the status column. You can sort by the status column to group all these tracks together.

RELOCATE LOST FILES

This feature finds music and folders on your computer that you have either moved or altered.

1. Click the relocate lost files button to search all your drives (internal and external) for files currently marked as not found in your library.
2. When this process is complete, your Scratch Live library will be updated with the new location of your files.

TIP: Drag and drop files, folders, or drives onto the relocate lost files button from the files pane. This is useful if you know the location of your files, as it only scans the drag and drop location, with faster relocation.

DELETING CRATES & TRACKS

To delete tracks from your Scratch Live library, select the track and use the keyboard shortcut ctrl-delete. Make sure you have the **Protect library** option unchecked in the Library tab of the Setup screen.

- Deleting a track when you are in the “* All...” playlist removes it from your library and any crates that the track may be in.
- Deleting a track inside a crate removes it from that crate but the file will remain in your “* All...” playlist.
- Deleting a track from a subcrate will remove it from the subcrate and the main crate but not the “* All...” playlist.
- Crates that are deleted are sent to the recycle bin/trash.

NOTE: To delete any files from your library and your hard drive (sending them to the recycle bin) use the shortcut ctrl-shift-delete.

If you are using iTunes playlists, your files cannot be deleted this way. You will need to delete them from within iTunes.

COPYING & MOVING FILES & FOLDERS

Scratch Live gives you the ability to copy and move files, folders and crates between drives or to a new location on the same drive.

To copy or move your files and/or folders, open the Files panel and select, drag and drop them in the desired new location. Scratch Live will then prompt you with the following options:

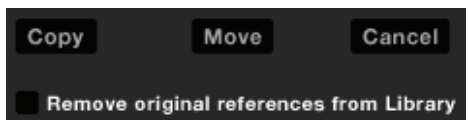

Copy: Select this to make a copy of the selected files and folders in the new location. Your Scratch Live library will now contain entries for both the originals and copies.

Move: Select this to move the selected files and/ or folders to the new location. Your Scratch Live

library and crates will now reference the files in their new location.

Cancel: Cancel any changes.

Remove original references from library:

Check this option when using the copy feature to remove the original references to these files in your Scratch Live library and replace them with the copies in the new location. The original files will still be kept in their current location, but will no longer be referenced in your Scratch Live library.

COPYING AND MOVING CRATES

You can also copy or move your Crates and Subcrates to another drive in the same way. Open the Files panel and select, drag and drop your Crates or Subcrates to the new drive. You will be presented with the same options as mentioned above.

SCRATCH LIVE BACKUP

Scratch Live stores your library database and crates information in the Scratch Live folder on your hard disk. This folder is created on a drive when files are added to Scratch Live. A copy of each Scratch Live folder called ScratchLIVEBackup is created next to the folder it is backing up. This folder is created when exiting Scratch Live. You will be prompted to backup your Scratch Live library on exit if there is no backup for a drive or if the last backup is more than 1 week old.

Backup will only keep ONE level backup at a time; each time backup runs it overwrites the previous backup.

Note: Make sure you back up your music separately. This backup function only backs up the Scratch Live folder, not your music files.

RECORDING

Scratch Live allows you to record one of six stereo signals from the TTM 57SL:

- Main Mix
- AUX BUS (sum of MIC, AUX, FlexFX Return)
- PGM 1 (a) Pre-Fader
- PGM 1 (a) Post -Fader
- PGM 2 (b) Pre-Fader
- PGM 2 (b) Post -Fader

Stereo recording is possible even while using two stereo vinyl control inputs.

1. Click on the ▼ triangle for the drop menu displaying the three record Input Sources.
2. Select the desired source and press the red record icon to start recording.
3. The record icon flashes while recording and the display shows the elapsed recording time.
4. Press the record icon again to stop the recording.
5. To save the recording, type in a name for the recording and click the save icon.
6. The recording is automatically placed in a crate named "RECORDED". If the crate does not already exist, it will be created automatically.
7. To start a new recording without saving, simply click the record button again.

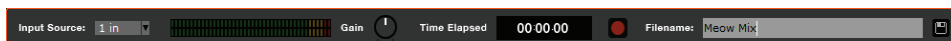

Recordings can be loaded onto the Decks, renamed, and managed like other files. Recordings are saved as 16-bit, 44.1 kHz stereo AIFF files.

Recordings are saved in "My Documents\My Music_Serato_Recording" in Windows XP, "Libraries\Music_Serato_Recording" in Windows 7, and "~/Music/_Serato_/Recording Temp" on a Mac.

RECORD GAIN KNOB

Adjust the record level using this knob. The meter tells you the level of your audio. Ideally the meter should sit just below the red, meaning your signal is as loud as it can be without clipping.

NOTE: If you turn the record gain knob down and the red clip led is still illuminated, this means the signal is clipping the input of the TTM 57SL. Turn down the mixer's GAIN control.

TIPS

- The keyboard shortcut ctrl-n turns recording on and off.
- You can load a recording without saving it using the short cut keys shift + left arrow to Virtual Deck 1 or shift + right arrow to Virtual Deck 2.

Recording directly with the TTM 57SL soft controls is possible using the Record Group and an optional footswitch.

NOTE: Recordings over 3 hours are automatically split into individual files.

LIVEFEED

LiveFeed allows you to stream any of the standard record sources (mix, aux, a pre, a post, b pre, b post) to a Virtual Deck. You can then instantly play the recording back just like a normal audio file - you can scratch it, speed it up, slow it down, set loops and set cue points.

There are two recording options, normal and gated. The normal option means recording will begin as soon as the Deck starts playing. The gated option means recording will only begin once the input source exceeds the set gate level (thus avoiding periods of silence). You can set the gate level by clicking the dropdown menu in the LiveFeed filename. The lower the gain setting the more sensitive the gate is.

The amount of time available to record is determined by your audio cache setting. The track overview display shows the amount of usable audio you have to play with from the recording. Click anywhere in the track overview display to jump to your desired position in the recording. **SEE "AUDIO CACHE" ON PAGE 37.**

USING LIVEFEED

First locate the LiveFeed files in your library. Type "livefeed" into the search box and you will see: LiveFeed - Rane TTM 57SL Record Source and LiveFeed - Rane TTM 57SL Record Source (Gated).

Load the desired LiveFeed file to any Deck. To begin recording, start the Virtual Deck playing. The waveforms will start to build in the track overview and main waveform display as the input source is being recorded. Performing a needle drop on the record brings the playhead back to the "now" position in the audio stream.

MIXING WITH ONE TURNTABLE OR CD PLAYER

This single turntable technique allows you to mix as if you had two turntables, using just one. If one of your turntables is not performing properly, or if you only have one available, you will be able to continue to mix the way you are used to.

The following is a step-by-step description of how to do perform a mix using only your right turntable or CDJ with the instant doubles feature.

MENU SETTINGS

Go to the Playback tab in the Setup screen. Make sure **Instant doubles** is checked, and **Lock playing deck** is unchecked.

1. Load a track onto the right Deck in Scratch Live and play as usual.
2. Put the left Deck into **INT** mode.
3. Load the same song you have playing on the right Deck onto the left Deck. The track on the left will start playing from the same point and at the same pitch as the right Deck.
4. You can now quickly slide the cross fader over to the left Deck.
5. Your right Deck is now free to load up a new song ready to mix in.
6. Repeat!

Tip: Instant Doubles works with either Deck.

SEE “LOCK PLAYING DECK” ON PAGE 34.

SEE “INSTANT DOUBLES” ON PAGE 35.

ADDITIONAL SETUP

This section covers general preferences and adjustments you can make to improve the performance of Scratch Live. Click on **SETUP** to get to this area.

HARDWARE

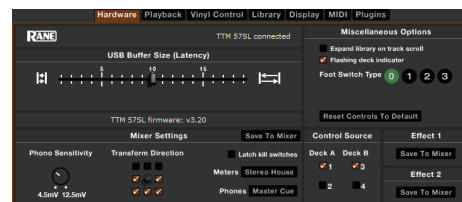

USB BUFFER SIZE (LATENCY)

Scratch Live processes audio in small chunks. When smaller chunks are used, the movement of the record is translated into audio more often, which results in a lower overall system latency. However, this requires more processing and therefore a higher CPU load, so lower buffer size settings require a more powerful computer to produce uninterrupted audio. If you want tighter control, you should try decreasing this setting, on the other hand, if you experience audio dropouts, you need to increase this setting (or get a more powerful computer).

UPDATE FIRMWARE

If a firmware update is available after installing a new Scratch Live software release, an **Update Firmware** button appears. The firmware upgrade takes approximately 10 seconds, during which time the mixer will not be usable. If for any reason the firmware upgrade does not work, just turn the mixer off and back on again. It's not possible to damage the mixer whilst performing a firmware upgrade.

NOTE: Newer firmware may not work with older versions of Scratch Live. The mixer will still be usable with older Scratch Live versions, but the effects do not display parameter values onscreen so you will not be able to see how the effects are configured. You will have the same control over the effects that you have when using effects without Scratch Live connected.

If you are using a mixer that is not yours and shared by other people please DON'T UPGRADE their firmware without their permission. If you don't click on Firmware Update, the mixer will run fine on the older firmware without the new

effects. **If you have upgraded your firmware and you need to downgrade please do the following:**

1. Run the older version of Scratch Live with the mixer attached.
2. Power off the mixer.
3. Hold the two High kill buttons down while powering on the mixer.
4. The kill lights will all be lit up red, and the firmware will downgrade to the version that shipped with that Scratch Live version. When the kill lights go out, the update is complete.

SAVE TO MIXER

Click these buttons to transfer settings to the mixer. The Save To Mixer buttons in the Effects sections save to the mixer processors independently so it can be used without Scratch Live running and attached. The following settings are transferred to the mixer in the main setup section.

- Transform direction.
- Latched or momentary kill switch preference.
- Phono sensitivity.
- Meter setting (Stereo House / Dual Mono Cue)
- Phones setting (Master / Cue)
- Effect 1
- Effect 2

PHONO SENSITIVITY

Set the phono sensitivity at the level of your cartridge (see your cartridge documentation for the value). This will make your turntable inputs the same level as your line inputs.

TRANSFORM DIRECTION

The Joysticks also double as transform switches. To change the joystick from software control to transform, press the joystick down – as if you were trying to push it down into the mixer, you’ll hear a click – and hold it down until the green LED lights.

The 8 check boxes around the joystick image show the directions you can move the joystick. The audio will cut out when the joystick is moved in a direction that is checked.

LATCH KILL SWITCHES

The EQ kill switches on the mixer can be set to be either momentary (on while the button is held down) or latched (on until the button is pressed on). Select this option to keep the kills on until you press the button again.

METERS

This button switches the meter mode, which is reflected by the mixer hardware.

PHONES

This button changes the state of the Master Cue button on the mixer.

EXPAND LIBRARY ON TRACK SCROLL

With this option turned on, the hardware panel will hide temporarily while you are using the mixer to scroll through your library.

FLASHING DECK INDICATOR

The flashing deck indicator shows which Virtual Deck is selected by the deck button on the mixer. When this option is on, a white border will flash around the selected virtual deck.

FOOT SWITCH TYPE

The TTM 57SL supports 1, 2 or 3 button footswitches. Click on the number that corresponds to your foot switch.

RESET CONTROLS TO DEFAULT

Each of the software control assignments can be customized. Click this button to reset all the control assignments/mappings to their default state.

CONTROL SOURCE

Any of the four inputs on the TTM 57SL can be set to control Scratch Live. Use the check boxes to choose the inputs that are used to control Scratch Live.

EFFECT 1 & EFFECT 2

SEE “SAVE TO MIXER” ON PAGE 34

PLAYBACK

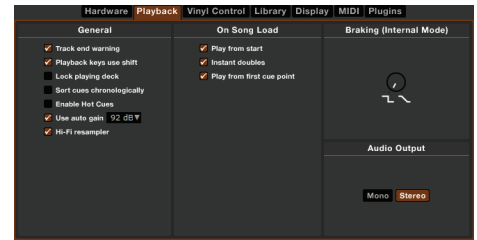

TRACK END WARNING

Enable track end warning to flash the virtual deck as you approach the end of the track. The label will start flashing 20 seconds from the end of the record. The track end warning does not apply to any tracks under 1 minute long.

PLAYBACK KEYS USE SHIFT

This is checked by default. Unchecking this option will enable all of these keys without pressing shift or having caps lock on. This applies to all cue points (1...0) and cue controls (QWERTY etc). **SEE “KEYBOARD SHORTCUTS” ON PAGE 54.**

LOCK PLAYING DECK

Every DJ’s nightmare used to be lifting the needle off the wrong turntable in the middle of a set. This setting helps to avoid the digital equivalent; loading a new track to the wrong deck. When this option is checked, you can only load a track if the target deck is stopped.

SORT CUES CHRONOLOGICALLY

The five cue points can be placed in any order, and can be dragged up and down if you wish to reorder them. If you prefer to lock them to chronological order, turn this option on.

ENABLE HOT CUES

When hot cues are enabled, you can set cue points simply by pressing the number keys 1 through 0 (no ctrl modifier required). Note that you can only add cues this way if the cue point slots are empty. **SEE “CUE POINTS” ON PAGE 21.**

USE AUTO GAIN

Auto gain enables you to set a uniform volume level for the tracks in your library. When a track is in auto gain mode, the track gain knob appears depressed.

Check this box to enable auto gain. Provided you have analyzed your files, your tracks will now be loaded with the auto gain applied.

Next to this box is a drop down menu, in which you set the target gain volume level.

To find the optimum setting, load a track with an average volume level onto one of the Virtual Decks. Now play the track, and take note of the volume and LED lights inside the software.

The idea is for the track volume to be sitting just under the clipping point (indicated by the LED meter red-lining). If the track is too quiet, unload it, then go to the Playback Setup screen and boost the auto gain dB value more.

Once you've made this adjustment, load the same track onto the Virtual Deck again. You'll notice that the volume knob has automatically adjusted itself.

Keep making adjustments on the same track until it's just below the clipping point. Once this is set you won't need to adjust the target gain level ever again.

Because the track you used had an average volume level, most of the other tracks in your library should be around the same volume. You may still need to make minor adjustments to some individual tracks, but once that's done these will stay saved in the ID3 tag of the file.

TIP: Slightly too quiet is always better than too loud. If your LED meter is in the red, it is likely that it is clipping. Not only does clipping not sound very nice, it can damage your equipment.

HI-FI RESAMPLER

This significantly reduces digital distortion at very slow or very fast record speeds, increasing the CPU load slightly. This option is off by default, the old resampler is used when switched off.

PLAY FROM START

Enable this to start all tracks from the beginning when loaded in REL and INT modes. If this setting is not enabled, freshly loaded tracks will continue to play from the point the last track was at. This option is on by default.

INSTANT DOUBLES

This allows you to quickly match the playhead position of two tracks. With this option set, when you load a track on one Virtual Deck that is already loaded on the other Virtual Deck (it must be the same file), the playhead will jump to the position of the track that was loaded first, with the keylock state and looping settings copied. This setting overrides the **Play from start** and **Play from first cue point** options.

PLAY FROM FIRST CUE POINT

Enable this option to start all tracks from the first cue point when loaded in REL and INT modes. This setting overrides the **Play from start** option.

BRAKING (INTERNAL MODE)

In INT mode, this controls how fast the deck stops when play is stopped. Counter-clockwise, the stop is immediate. Clockwise rotation increases the stop from a finger grab all the way to a slow turntable power-down.

AUDIO OUTPUT

By default the output of Scratch Live is stereo. You can also select mono output. This setting is saved when you exit Scratch Live.

VINYL CONTROL



ADJUST LOOPS WITH VINYL

Loop end points can be adjusted using the control vinyl. Disable this option if you wish to use the computer's arrow keys to adjust loops, and keep audio playback controlled by the vinyl. **SEE "LOOPING" ON PAGE 21.**

NEXT SONG ON FLIP

When this option is enabled, changing the side of control vinyl you're using ("flipping the record") loads the next song, as with the Autoplay function. **SEE "PLAYBACK CONTROL" ON PAGE 15.**

ENABLE VINYL SCROLL

Uncheck this box to disable the Vinyl Scroll feature. **SEE "VINYL SCROLL" ON PAGE 15.**

REVERSE VINYL SCROLL

This setting allows you to reverse the direction of Vinyl Scroll. **SEE "VINYL SCROLL" ON PAGE 15.**

VINYL SCROLL SPEED

Vinyl Scroll allows you to load a new track without touching the computer, simply by lifting the needle and placing it in the special section of side A of the control record. This setting allows you to adjust the sensitivity of Vinyl Scroll, so that you can control the amount of record movement required to move between tracks.

DROP TO ABSOLUTE POSITION

This detects a deliberate repositioning of the needle, and moves the playhead to the absolute position of the needle, as in ABS mode. Accidental skipping of the needle does not reposition the playhead.

DROP TO CUE POINTS

This option triggers the corresponding cue point when the needle is repositioned into one of the first 5 one-minute sections on the control vinyl. For instance: needle dropping into the second minute on the left turntable, will send playback for Deck 1 to cuepoint 2, if that cuepoint is set.

VINYL START OFFSET

If you find that you have cue burn at the beginning of the record, you will notice that the tracking will be poor at this point. Use the two knobs to offset the start point, so that the track will start playing from a point further into the control record. The first knob sets the number of whole minutes to offset by, the second knob sets the number of whole rotations within that minute.

LIBRARY

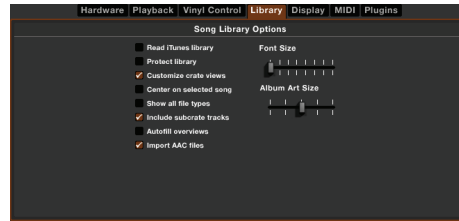

READ ITUNES LIBRARY

Check this option to show your iTunes library and playlists in Scratch Live. You can collapse your iTunes playlists by clicking on the  icon.

Uncheck this to remove iTunes playlists and itunes songs from your Scratchlive library.

To add your iTunes music to your Scratch Live library permanently, drag and drop tracks from the iTunes playlists onto the “* All...” icon (on the far left hand side of the Scratch Live screen), or into individual Scratch Live crates.

Any files moved to “* All...,” an existing crate, or a new crate will now remain in Scratch Live even when the **Read iTunes library** option is unchecked. Once a file has been permanently added to Scratch Live, the iTunes logo will disappear.

We recommend unchecking this option after you have added your music into the Scratchlive library.

NOTES:

- If your iTunes library contains a large number of tracks it may take some time for Scratch Live to read it.
- Any changes made in Scratch Live to the file information of tracks in your iTunes library will not appear in iTunes until after you play the track.
- Scratch Live cannot play files that have been protected by Digital Rights Management systems, such as those previously sold through the Apple iTunes Music Store. iTunes Plus files are DRM-free.
- iTunes is available for Mac and PC. For more information, visit www.apple.com.

PROTECT LIBRARY

Uncheck this setting to remove files and crates from your library. Enable to lock your library and prevent accidental file or crate deletion while using Scratch Live. Enabling this setting will also lock all file tags and crate names, so that no text can be changed.

CUSTOMIZE CRATE VIEWS

Check this option to set custom column views for each crate and playlist. When the option is off (default), all crates will share the same column configuration as the “* All...” crate.

CENTER ON SELECTED SONG

With this option on, scrolling up and down in your Library holds the selected track in the middle of the Library panel.

SHOW ALL FILE TYPES

Enable this option to show all files when importing tracks into Scratch Live. If this option is not selected, only files that Scratch Live can play will be displayed.

INCLUDE SUBCRATE TRACKS

You can drag crates into other crates to make subcrates. If you have this option turned on, any crate will also display the contents of all its subcrates. **SEE “ORGANIZING YOUR MUSIC” ON PAGE 27.**

AUTOFILL OVERVIEWS

Enable this setting to automatically generate the track overview as soon as a track is loaded. If this setting is not enabled, the track overview will be generated as the track plays. Automatically generating the track overview uses more of the computer’s CPU power, and should be disabled on slower computers.

TIP: Analyze your files before you play to pre-build all your overviews. SEE “PREPARING YOUR FILES” ON PAGE 14.

IMPORT AAC FILES

Turn this option off if you do not wish to import AAC files into your library. Changing this option will cause your iTunes library to be reloaded if you have the **Read iTunes library** option turned on.

FONT SIZE

Adjust this slider to increase and decrease the font size for the main library and crates area.

TIP: You can also use the keyboard shortcuts `ctrl +` and `ctrl -` to increase and decrease the font size.

ALBUM ART SIZE

Adjust this slider to set the maximum album art size for any of the album art display modes. The artwork will still get larger if required to fit the track and will still scale with the library zoom keyboard shortcut.

DISPLAY

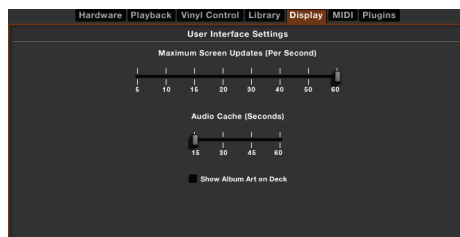

MAXIMUM SCREEN UPDATES

This feature allows you to throttle back the screen refresh rate. Users with slower computers might like to do this if they are having performance issues. It could also be useful if you want to limit Scratch Live's processor usage, for example if you are running a recording program at the same time. The default setting is 60 Hz, or refreshed 60 times per second. This setting applies to the entire screen (i.e. the Virtual Decks, the Waveforms, the Library, and the Setup screen).

AUDIO CACHE

Use the slider to set the amount of audio that is loaded into memory. A small audio cache will place less load on your computer, and the tracks will load faster. A large audio cache will give you a bigger view of the waveform when the main waveform view is zoomed out.

SHOW ALBUM ART ON DECK

Check this option to show the album art for your songs next to the track information display on each virtual deck.

PLUGINS

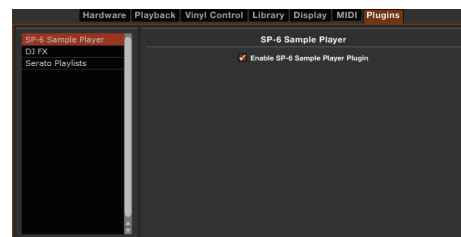

SP-6 SAMPLE PLAYER

Use the check box to enable and disable the SP-6 sample player plugin. The SP-6 is enabled by default.

DJ-FX

Use the check box to enable and disable the DJ-FX plugin. The DJ-FX plugin is disabled by default.

SERATO PLAYLISTS

Use the check boxes to enable and disable the Serato Playlists plugin and the Live Playlists feature. These are disabled by default.

THE HARDWARE CONTROL PANEL

On the left side of the screen, click the **Hardware** button to show the hardware control panel.

You can control many of the features of Scratch Live directly from your TTM 57SL mixer. The hardware panel shows you what functions in the software are connected to the physical controls on the mixer, and allows you to customize the control assignments. It also provides an interface for the effects running in the mixer.

TTM 57SL CONTROL OF SCRATCH LIVE

Each of the controls on the mixer controls a software function in Scratch Live.

Each parameter knob (labelled **P1** and **P2** on the mixer) has two states. The LED next to **P1** and **P2** on the mixer indicates the state: the control above applies when the LED is off, the control below applies when the LED is on. Some controls, such as “tap tempo”, and “load track” are momentary.

The joysticks **J1** and **J2** also have two states. When the LED next to **J1** or **J2** is on, the joystick controls Scratch Live software. When the LED is not lit, the joystick acts as a transform switch. To switch between using the joystick as a control for Scratch Live and a transform switch, press the joystick straight down and hold it down.

NOTE: the joystick is also a button, press it straight down, as if you were trying to push it into the mixer — you will feel it click.

When you are in transform mode, the LED next to the joystick is not lit, and its controls on the Scratch Live hardware panel are grayed out.

GROUPS

Functions are organized in a series of groups. Each group contains a bank of software controls. The first two groups are custom groups, designed to contain the commands you need most often during a set. The next four groups contain other functions ordered by category.

To access a group, press the GROUP button on the mixer, then press:

- B1 – General:** Custom group 1, with the most common commands.
- B2 – Library:** Custom group 2 — move through library, make new recordings.
- B3 – Playback:** Control all playback functions directly from the mixer.
- B4 – Cue/Loop:** Full control over all cue points on both Virtual Decks and looping.
- B5 – Recording:** Select source and start / stop / save / play recordings.
- B6 – Effects:** Select and insert effects. Adjust effect parameters.

CUSTOMIZING CONTROL ASSIGNMENTS

You can customize almost all of the software control assignments. To change what a button, parameter knob or joystick does to Scratch Live, right-click (PC) or control-click (Mac) on the control label while in Groups 1 through 5. A list appears, and you can choose the new function you wish to have associated with that control.

Some software functions can be assigned to either the left or the right Virtual Deck. If you choose a function that can be assigned to a Deck, after you select the function from the menu, you will be presented with another list. Choose selected Deck to have the function controlled by the DECK button on the mixer, or Left Deck or Right Deck to have it always apply to one of the Decks.

Any customization resides in the computer, not in the mixer. This means that if two different DJs, each with their own laptop, use the same mixer, each DJ can have their own custom groups.

TTM 57SL CONTROL OF DJ-FX

The following DJ-FX controls are assignable from the TTM 57SL control assign popup menus:

Knobs:

- Beats
- Select Effect
- Super Knob 1
- Super Knob 2
- Super Knob 3
- Ultra Knob

Buttons / Joysticks / Knob Press:

- Beats Double
- Beats Half
- Select Deck 1
- Select Deck 2
- Select Next Effect
- Select Previous Effect
- Super Effect 1 On
- Super Effect 1 On (Momentary)
- Super Effect 2 On
- Super Effect 2 On (Momentary)
- Super Effect 3 On
- Super Effect 3 On (Momentary)
- Super Knob Mode
- Ultra Knob Mode
- Ultra Effect On
- Ultra Effect On (Momentary)

When you select a DJ-FX control from the popup menu, you are offered to select the Left or Right DJ-FX unit to control that function.

DEFAULT CONTROL ASSIGNMENTS

If DJ-FX is enabled, Group 5 on the TTM 57SL is set to correspond to the default DJ-FX controls. If Video-SL is enabled, then Video-SL controls overwrite the DJ-FX controls. If neither of them are enabled, then Group 5 corresponds to the recording panel.

1 (GROUP B1) GENERAL CONTROLS (CUSTOM GROUP 1)

This is the first group shown below with default commands when you first start Scratch Live. These give you basic playback controls and up to three cue points per Virtual Deck. The orange left arrows (←) control the left Virtual Deck and the blue right arrows (→) control the right Virtual Deck. The joysticks default to transform mode (LEDs off). Press the joystick in (LED on) to activate its controls as shown here.

Push to load track on left Deck. Scroll through your crates and library. Push to load track on right Deck.

Hold the joystick up to play the track backwards momentarily then release to jump ahead with timing intact.

Joystick left to 'Double': Copy the track from the right Deck to the left Deck.

Hold the joystick down and press a B button to set a cue point on the left Deck.

Jump to cue points on the left Deck.

Control looping from the footswitch.

Jump to cue points on the right Deck.

Joystick right to 'Double': Copy the track from the left Deck to the right Deck.

Joystick left to jump to the temporary point on the right Deck.

2 (GROUP B2) LIBRARY (CUSTOM GROUP 2)

In this second custom group, many of the functions can be applied to either of the Virtual Decks. To select which of the Virtual Decks a given effect is applied to, press the mixer's DECK button. The LED next to the button indicates which of the Virtual Decks the software function applies.

Push to undo the last action. Scroll through your crates and library. Push to load.

Hold the joystick up to play the track backwards momentarily then release to jump ahead with timing intact.

Joystick right to 'Double': Copy the track from the left Deck to the right Deck.

Hold the joystick down and press a B button to set a cue point.

Jump to Cue points.

Control looping from the footswitch.

Loop On / Off (toggle)

Joystick left to 'Double': Copy the track from the right Deck to the left Deck.

< = previous loop.
> = next loop.

▶ (GROUP B3) PLAYBACK

To access this group, press the GROUP button on the mixer, then press B3. This group contains all the software functions required for mixing in int mode. To select which of the Virtual Decks a given effect is applied to, press the mixer's DECK button. The LED next to the button indicates which of the Virtual Decks the software function applies.

Push to undo the last action. Scroll through your crates and library. Nudge forward or back.

Hold the joystick up to play the track backwards momentarily then release to jump ahead with timing intact.

Push (LED on) and turn to quickly shuttle through the track.

Joystick waveform zoom. up = zoom in. down = zoom out.

Play the track reverse from the current position.

Play / Pause. Set temp cue point.

Hold to play from temp cue. Release returns to temp cue.

Control looping from the footswitch.

Playback modes.

<< = rewind.
>> = fast forward.

⌂ (GROUP B4) CUEING & LOOPING

To access this group, press the GROUP button on the mixer, then press B4. This group gives you access to all the cue points and looping functions. To select which of the Virtual Decks a given effect is applied to, press the mixer's DECK button. The LED next to the button indicates which of the Virtual Decks the software function applies.

Turn to adjust, push to set the 'loop in' point.

Turn to adjust, push to set the 'loop out' point.

Hold the joystick up or down and press a B button to set a cue point.

Jump to Cue points.

Control looping from the footswitch.

Loop On / Off (toggle).

> = Next Loop.
< = Previous Loop.

REC (GROUP B5) RECORDING

To access this group, press the GROUP button on the mixer, then press **B5**. In this group you can select your input source, start and stop recording, and load this new recording to either Virtual Deck.

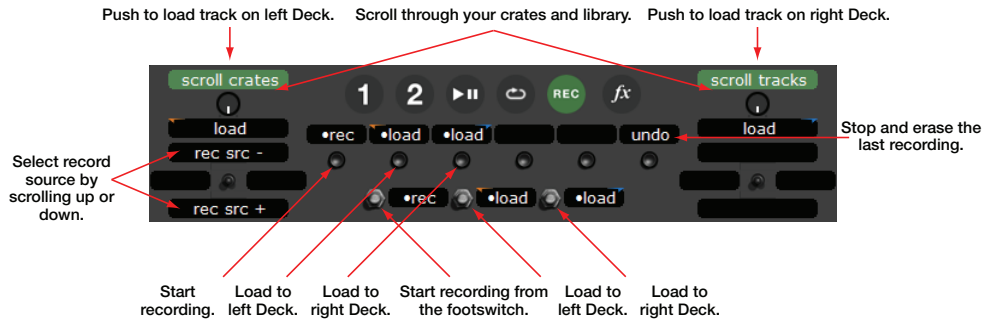

fx (GROUP B6) EFFECTS

The TTM 57SL has two built in effects processors. Unlike other groups, when you are in the effects group, the DECK button on the mixer switches between these two effects processors. DECK 1 activates Processor 1, and DECK 2 activates Processor 2. Each effect has parameters controlled by **P1** and **P2**. SEE: EFFECTS (PAGE 34)

The left joystick, **J1**, sets the BPM (tempo) multiplier. Set the BPM by tapping **P1** to the beat, or manually adjust by turning **P1**. The optional footswitch can also tap in the BPM. Use the left joystick to quickly halve, split, double or quadruple the tempo. The buttons **B1** through **B4** set the effect's insert point: either PGM, the Aux bus (which includes the Mic) or the Main output.

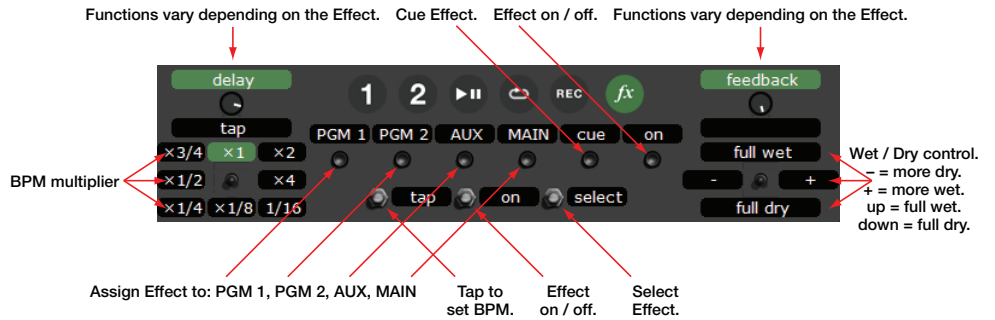

EFFECTS

HARDWARE & SOFTWARE CONTROL PANELS

These “soft” controls have multiple functions for controlling Scratch Live. These also control the Internal Digital Effects when the mixer is operated stand-alone without a computer. The Effects function the same way if connected to the Scratch Live software or when using the TTM 57SL without a computer.

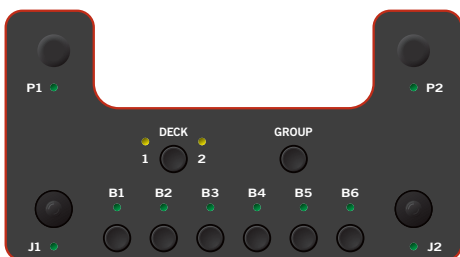

FOR MORE INFORMATION ON SCRATCH LIVE SOFTWARE CONTROL OPTIONS SEE “ADDITIONAL SETUP” ON PAGE 33.

INTERNAL DIGITAL EFFECTS

There are two Effects Processors available in the TTM 57SL. Digital Effects hang out in the mixer instead of the software so they are available for signal processing even when Scratch Live is not running. Each processor can load one of ten effects:

- Echo [post fader]
- Hold Echo [post fader]
- HP Echo [post fader]
- HP Hold Echo [post fader]
- LP Filter (Low Pass) [pre fader]
- BP Filter (Band Pass) [pre fader]
- HP Filter (High Pass) [pre fader]
- Phaser [pre fader]
- Flanger [pre fader]
- Desecrator [pre fader]

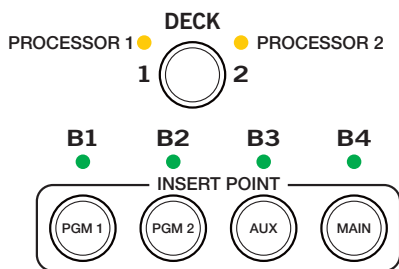

When Scratch Live is running, the deployed effect for each Effect Processor is shown onscreen, along with all of the control assignments and settings. The Effects are still available when the mixer is operating stand-alone, however, there is no display for indicating the deployed Effect, control assignment or settings.

Scratch Live software effect controls mirror the TTM 57SL front panel. When one status changes, so does the other.

For this reason, you may want to begin by using the Effects with Scratch Live software to learn control assignments. Typically, Effects are controlled by ear. If you know which Effect is installed in the Effects Processors and what controls are assigned to what functions, the Effects are very usable without the software. The function of the controls has been standardized to help keep stand-alone operation simple. The TTM 57SL ships with Echo in Processor 1, and LP Filter in Processor 2 before Scratch Live reassigns them.

NOTE: These defaults can be changed and saved to the mixer. SEE “SAVE TO MIXER” ON PAGE 34.

GROUP 6

If you are connected to Scratch Live, switch to Group 6 to begin using Effects. Press GROUP then **B6**. SEE “GROUPS” ON PAGE 38.

INSERTING AN EFFECT

There are four possible insert points for a deployed Effect: PGM 1, PGM 2, AUX BUS or Main Mix. When an Effects Processor is inserted in PGM 1 or PGM 2, pre- or post-fader operation is determined by the Effect. Both the Echo Effects are post-fader, and all the Filter Effects are pre-fader. Both Effects Processors can use the same insert point, but the order depends on the effect. For instance, the Filter effect will be processed first (because it is pre-fader), and the Echo effect will be processed second (because it is post-fader). If both are Filter Effects, Processor 1 will be first.

NOTE: Any Effect can only be loaded into one of the processors.

The controls required to select an Effects Processor and determine it’s insert point are shown below. The DECK button selects the Effects Processor to be controlled. Pressing the button toggles between Effects Processor 1 and Effects Processor 2.

- B1** inserts the selected processor in PGM 1.
- B2** inserts the selected processor in PGM 2.
- B3** inserts the selected processor in AUX Bus.
- B4** inserts the selected processor in Main Mix.

To share an effect with both PGM 1 and PGM 2, insert the effect in the Aux Bus and use the FlexFX switches. Remember that an effect in the Aux Bus affects the FlexFX, Mic and Aux Inputs.

BASIC EFFECTS CONTROLS

The selected effect is edited with the remaining soft controls. The function of some controls depends on the selected Effect. Specific control functions are detailed for each Effect. The basic operation of these controls is outlined here:

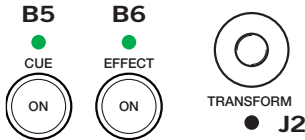

B5 Toggles the Effects Cue On / Off. This is a global setting and does not change state when toggling between Effects Processors. See the Effects Cueing section to the right for details.

B6 toggles the selected Effects Processor On / Off.

J1 and **J2** joysticks may operate as transform switches or be used to control effects parameters. **J1** and **J2** each feature an eight-position joystick, a push switch and a green mode indicator light.

- If the indicator light is off, the associated joystick operates as a transform switch.
- If the green indicator light is on, the joystick is assigned to an effect parameter as shown on the following pages. Pressing the joystick toggles between the two modes of operation. If a second function is not available, pressing the joystick has no effect. **SEE "TTM 57SL CONTROL OF SCRATCH LIVE" ON PAGE 38.**

P1 and **P2** may be used to control Effect parameters, each consisting of a rotary encoder, a push switch and a green mode light.

FOOTSWITCH

The last soft control is the optional footswitch. A footswitch allows hands-free control of these effects parameters:

- Tap to set the BPM.
- Turn the Effect on & off.
- Select between the two Effects Processors (same as the DECK switch).

The footswitch can also assist with looping and recording functions. These are shown in the Groups section. **SEE "FOOTSWITCH DIAGRAM" ON PAGE 55.**

EFFECTS CUEING

You can cue an effect before you turn it on so that you can check how it sounds before you bring it into the mix. Button **B5** turns the Effect Cue on or off. Note that if you turn Effect Cue on, it stays on even when you switch between effects.

For an Effect Cue to be heard in the headphones, the Effect Processor must be selected, Effect Cue must be on and the Cue Pan and Master Cue controls must be in the correct position.

- For instance, with a track playing in PGM 1:
1. Select Processor 1 to choose your Effect.
 2. Select **B1** to route PGM 1 to the Effect.
 3. Select **B5** to Cue the Effect in your phones.
 4. Select **B6** to send the Effect to the Master.
 5. Echo Effects are post-fader, so the fader needs to be up to send the Effect a signal. Other Effects do not rely on the fader.

The Effects Cue for an Effect inserted in Main or Aux Bus is only heard in the headphones if the Master Cue switch is on. The Hold Echos are the only Effects that cannot be heard in the headphones unless it is on and also sent to the Master.

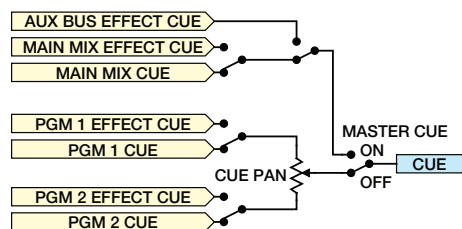

Effects Cue Logic Diagram

CONTROL ASSIGNMENT SUMMARY

FILTER EFFECTS

- P1** controls the design frequency.
- P1** second function taps the BPM, a single tap re-syncs the tag BPM.
- P2** controls the filter resonance.
- P2** second function controls the sweep depth.

ECHO EFFECTS

- P1** controls the delay amount.
- P1** second function taps the BPM manually, a single tap re-syncs the tag BPM.
- P2** controls the feedback.
- P2** second function (no effect in echo effects, filter cutoff frequency in HP echo effects).

PHASER

- P1** controls the design frequency.
- P1** second function taps the BPM, a single tap re-syncs BPM, BPM affects LFO sweep rate.
- P2** controls the feedback.
- P2** second function controls the phaser depth.

FLANGER

- P1** controls the base delay in ms.
- P1** second function taps the BPM, BPM affects LFO sweep rate.
- P2** controls feedback, providing fullness to the flanger effect.
- P2** second function controls the depth which represents the peak delay change.

DESECRATOR

- P1** controls the drive.
- P2** controls the down sampler.
- P2** second function controls the bit depth.

SWEEP FILTER CONTROL ASSIGNMENTS

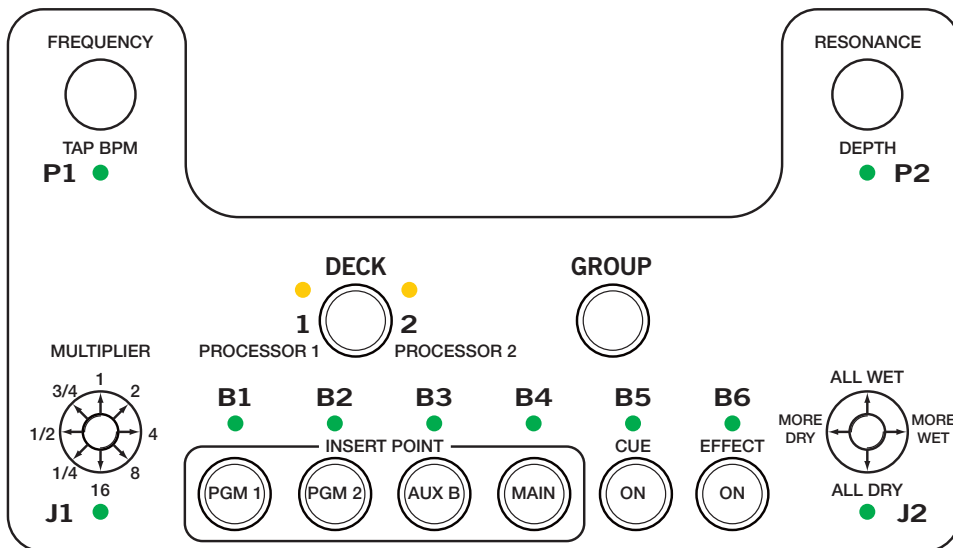

Three Filters have the same parameters, but are different filter types:

LP Filter is an automatically sweepable Low Pass Filter, with the following response:

31.5 Hz ← P1 • Frequency → 16 kHz

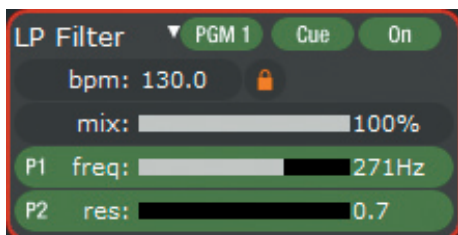
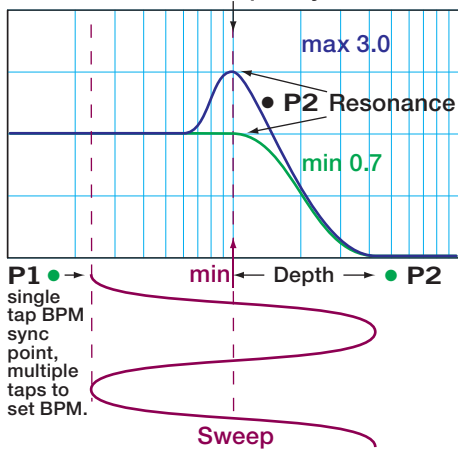

BP Filter is an automatically sweepable Band Pass Filter, with the following response:

31.5 Hz ← P1 • Frequency → 16 kHz

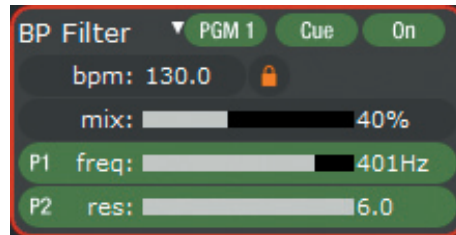
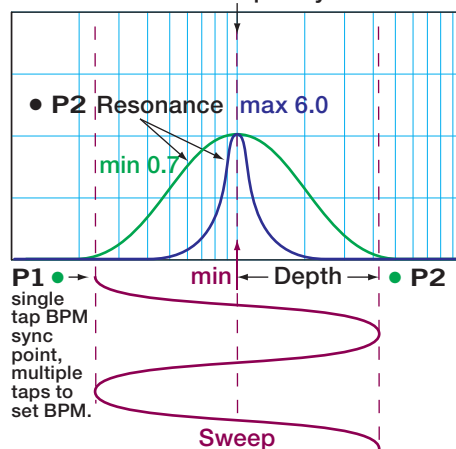

HP Filter is an automatically sweepable High Pass Filter, with the following response:

31.5 Hz ← P1 • Frequency → 16 kHz

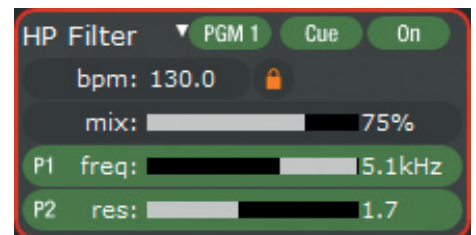
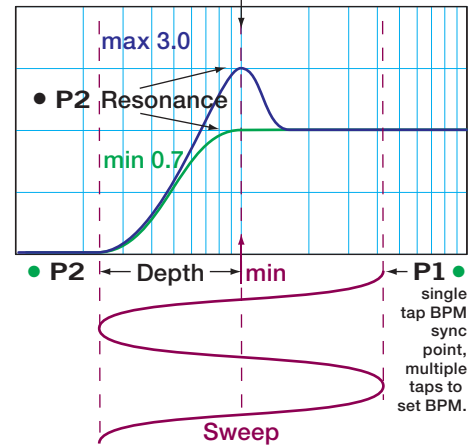

(In case you are wondering, a high pass is the same as a low cut.) Each Filter's settings are independent from the other Filters.

P1 FREQUENCY / TAP BPM

If the track has a BPM tag, the Filter sweep automatically matches it and a lock icon appears in the Filter section. To manually set the sweep BPM, tap **P1** to the beat. The default BPM is 120, and tapping **P1** can set it from 24 to 480 with a resolution of 0.1 BPM. A single Tap of **P1** resyncs the sweep to the BPM.

The primary function of **P1** (indicator off) is Cutoff Frequency, which starts at 722 Hz and is adjustable from 31.5 Hz to 16 kHz (9 octaves). The full sweep of the filter is reached in 1 1/3 rotations of **P1**.

J1 MULTIPLIER

The BPM Multiplier is selected with **J1**, which toggles between transform operation and BPM multiplier. If the green mode indicator is on, **J1** may adjust the multiplier to 16, 8, 4, 2, 1, 3/4, 1/2, or 1/4.

P2 RESONANCE / DEPTH

Resonance is adjusted using the primary function of **P2** (indicator off). The diagrams show the different resonances for each Filter type.

LP and HP Filter Resonance determines how peaked the cutoff is, which is adjustable over a range of 0.7 to 3.0.

BP Filter Resonance determines the width of the peak, which is adjustable over a range of 0.7 to 3.0.

Depth is adjusted using the second function of **P2** (green indicator on). Depth sets how far the sweep of the LFO (low frequency oscillator) modulates the Frequency set by **P1**. The Depth is adjustable ± 4.5 octaves. The full range is reached in $1\frac{1}{3}$ rotations of **P2**. With Depth at minimum, the LFO ceases to have any effect, and **P1** becomes a manual sweep control.

PHASER / FLANGER CONTROL ASSIGNMENTS

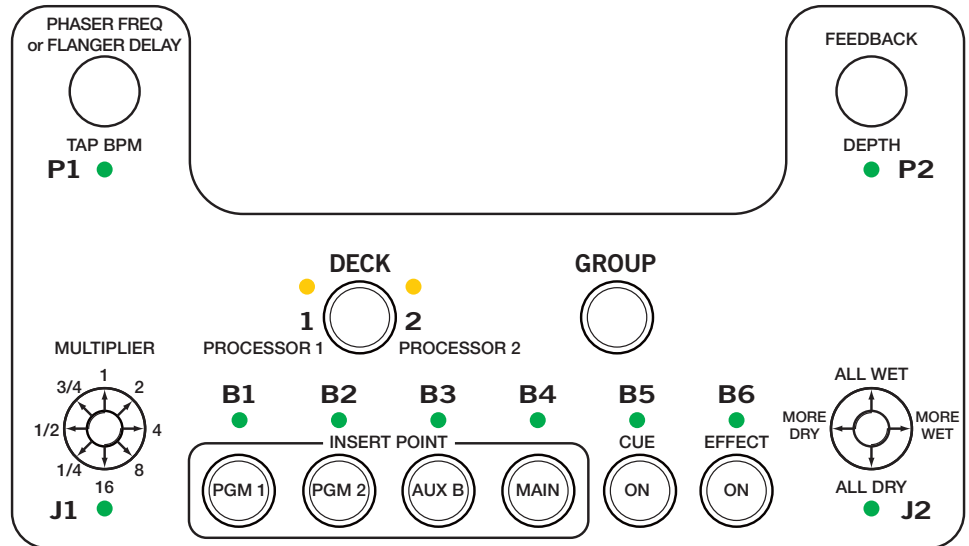

J2 WET / DRY MIX

Pressing **J2** toggles between transform operation (indicator off) and Wet / Dry control (green indicator on). The filter default is 100% wet. Holding the joystick left goes more Dry, to the right goes more Wet. Moving the joystick up provides instant, momentary 100% Wet. Moving the joystick down provides instant, momentary 100% Dry. This allows Wet or Dry transforming with the control returning to the set Wet/Dry ratio when the control is at rest (in the center).

Phasing is a swept comb-filter effect with no linear harmonic relationship between the comb teeth. Splitting an audio signal in two, shifting the phase of one signal by passing it through an all-pass filter, then recombining, creates the phasing effect. The control response is shown below.

A Flanger creates a unique “flyover” sound by creating a set of equally spaced notches in the the frequency spectrum in a linear harmonic comb filter. This is done by mixing a signal with a slightly delayed copy of itself and by constantly changing the length of the delay.

Both effects use an LFO to cause the comb peaks and notches to sweep up and down the frequency spectrum.

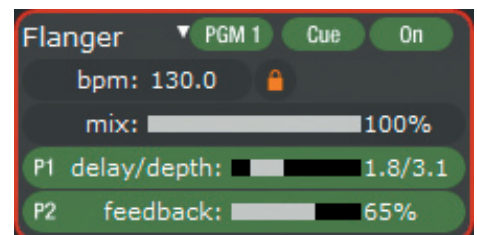
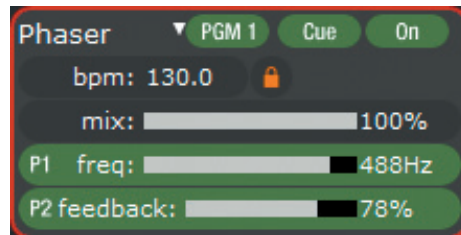
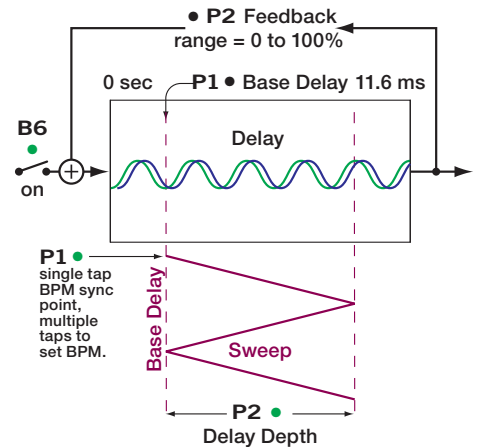
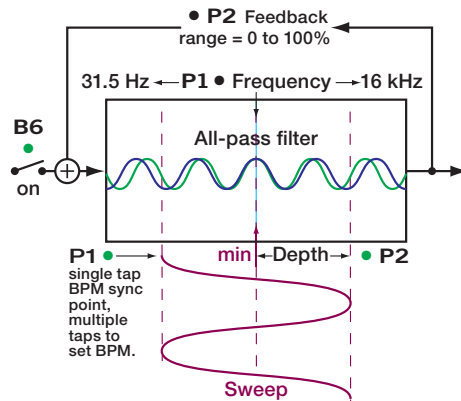

P1 PHASER FREQUENCY / FLANGER DELAY / TAP BPM

The Phaser's primary function of **P1** (indicator off) is filter design frequency, which starts at 722 Hz and is adjustable from 31.5 Hz to 16 kHz (9 octaves). The full sweep of the filter is reached in $1\frac{1}{3}$ rotations of **P1**.

The Flanger's primary function of **P1** (indicator off) is Base Delay, adjustable from 0 to 11.6 milliseconds. The Base Delay sets the high frequency point of the sweep. The Depth control (**P2**) sets the range of the swept comb filter.

If the track has a BPM tag, the sweep automatically matches it and a lock icon appears in the BPM section. To manually set the sweep BPM, tap **P1** to the beat. The default BPM is 120, and tapping **P1** can set it from 24 to 480 with a resolution of 0.1 BPM. A single Tap of **P1** resyncs the sweep to the BPM.

J1 MULTIPLIER

The BPM Multiplier is selected with **J1**, toggling between transform operation and BPM multiplier. If the green mode indicator is on, **J1** may adjust the multiplier to 16, 8, 4, 2, 1, $\frac{3}{4}$, $\frac{1}{2}$, or $\frac{1}{4}$.

P2 FEEDBACK / DEPTH

Feedback is the primary function of **P2** (indicator off) controlling the amount of phased or delayed signal fed back to the input, increasing "fatness." Minimum to maximum is $1\frac{1}{3}$ rotations of **P2**.

Depth is adjusted using the second function of **P2** (green indicator on). Depth sets how far the sweep of the LFO (low frequency oscillator) modulates the Frequency (Phaser) or Delay (Flanger) as set by **P1**. The Phaser Depth is adjustable from 0 to ± 4.5 octaves, and the Delay Depth is adjustable from 0 to 11.6 ms. The full range is reached in $1\frac{1}{3}$ rotations of **P2**. With Depth at minimum, the LFO ceases to have any effect, and **P1** becomes a manual sweep control.

J2 WET / DRY MIX

Pressing **J2** toggles between transform operation (indicator off) and Wet / Dry control (green indicator on). The phaser / flanger default is 100% wet. **J2** has the same operation on all effects. SEE "J2 WET / DRY MIX" ON PAGE 44.

ECHO EFFECTS CONTROL ASSIGNMENTS

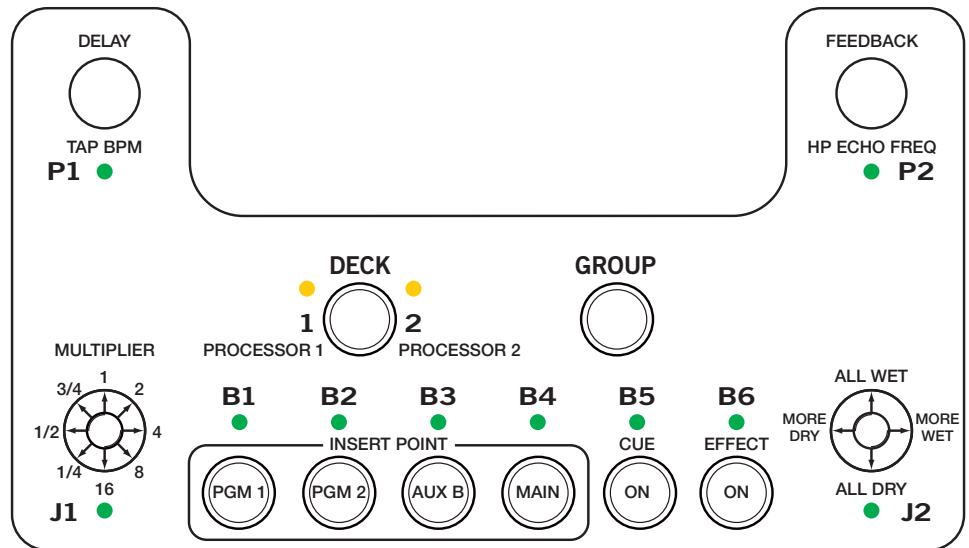

If the track has a BPM tag, the Echo BPM is automatically set and a lock icon appears in the Echo section. To manually set the BPM of the Echo, tap **P1** (or the footswitch) to the beat.

ECHO EFFECT DIFFERENCES

- Feedback starts at 70% and is adjustable from 0% to 94%.
- Feedback generates as long as it is inserted.
- **P2** has no second function in the Echo Effect.

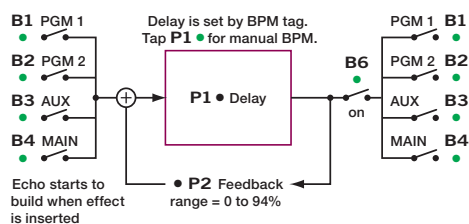

HP ECHO EFFECT DIFFERENCES

- Each delay cycle repeatedly runs through a second-order High Pass Filter having a set resonance of 0.7.
- Filter Cutoff Frequency is adjusted with the second function of **P2** (green indicator on), adjustable from 31.5 Hz to 16 kHz (9 octaves). The full sweep of the filter is reached in $1\frac{1}{3}$ rotations.

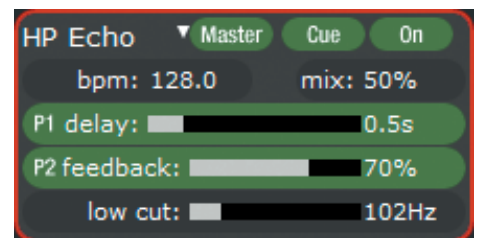
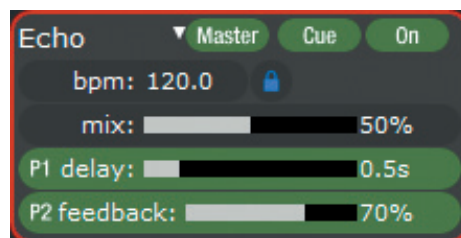
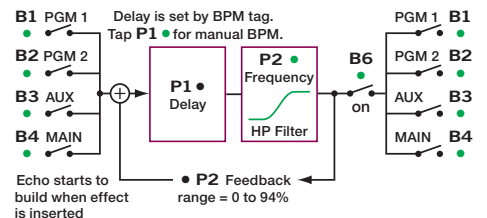

P1 DELAY / TAP BPM

Once you turn **P1**, the lock icon disappears, the Multiplier number turns white and **P1** becomes a Delay control. Delay has a range of 1ms to 2.9 seconds, and a track without a BPM tag will start at 500 ms. A slow turn gives 1ms adjustment resolution, while a fast turn increases the resolution to 200 ms per step. To get back to the original BPM after adjusting Delay, select a multiplier with **J1**, and the Multiplier number changes to green. A single Tap of **P1** will resync the delay to the BPM.

J1 MULTIPLIER

Pressing **J1** toggles between normal transform operation (indicator off) and the BPM Multiplier (green indicator on). With the green indicator lit, **J1** adjusts the multiplier to 4, 2, 1, 3/4, 1/2, 1/4, 1/8, or 1/16. Multipliers that exceed the Delay memory will not function and are grayed-out in the software control panel. If BPM is set with tapping, the multiplier is set to 1. The multiplier is not reset when the BPM is set via the ID3 tag, so your subsequent tracks can stay at x4 if you wish. The active Multiplier is shown in green text when locked to a BPM.

P2 FEEDBACK

Feedback is the amount of delayed signal fed back to the delay input. Feedback minimum to maximum is 1 1/3 rotations of **P2**. The Delay clears after one circulation when Feedback is brought to 0%. The Delay clears immediately when uninserted, but changing the insert point does not clear the feedback loop. This is useful for adding PGM 2 Echo to the fading PGM 1 Echo. To clear the loop and start a fresh Echo immediately, rapid double-click on the insert point **B1**, **B2**, **B3** or **B4**.

J2 WET / DRY MIX

Pressing **J2** toggles between transform operation (indicator off) and Wet / Dry control (green indicator on). The echo default is 50% Wet / 50% Dry. **J2** has the same operation on all effects. SEE "J2 WET / DRY MIX" ON PAGE 44.

HOLD ECHO CONTROL ASSIGNMENTS

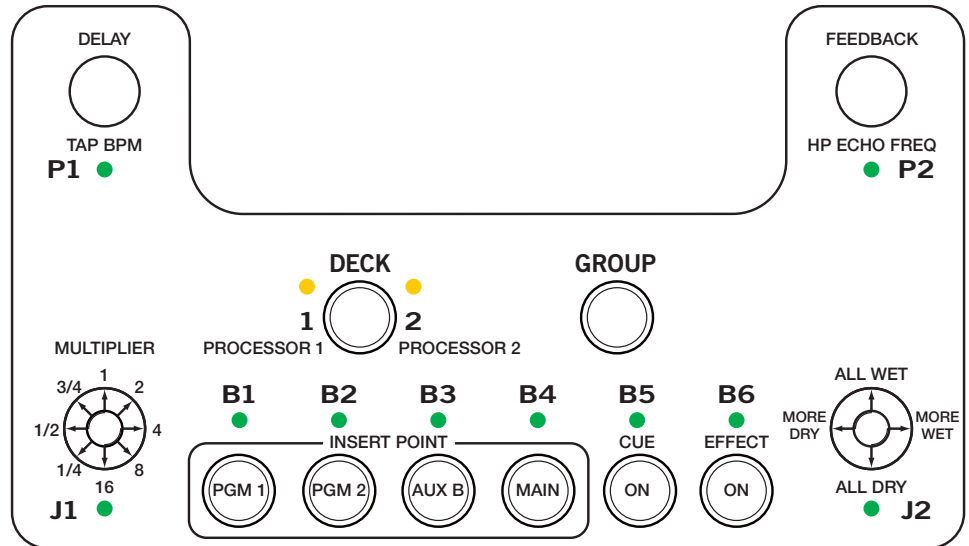

If the track has a BPM tag, the Echo BPM is automatically set and a lock icon appears in the Echo section. To manually set the BPM of the Echo, tap **P1** (or the footswitch) to the beat.

HOLD ECHO EFFECT DIFFERENCES

- Feedback starts with 100% but adjustable to 0% with **P2**.
- Feedback generates as long as it is inserted and **B6** is on.
- Delay still loops after **B6** is off. If Feedback is set to 100% it will loop for days. The loop will decay if Feedback is reduced. Uninsert the Effect to stop the loop immediately.
- **P2** has no second function in the Hold Echo.

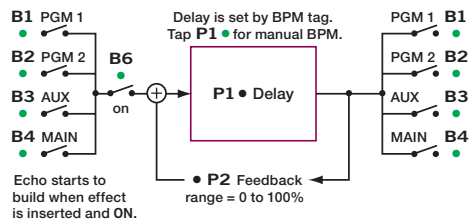

HP HOLD ECHO EFFECT DIFFERENCES

- Each delay cycle repeatedly runs through a second-order High Pass Filter having a set resonance of 0.7.
- Filter Cutoff Frequency is adjusted with the second function of **P2** (green indicator on), adjustable from 31.5 Hz to 16 kHz (9 octaves). The full sweep of the filter is reached in 1 1/3 rotations.

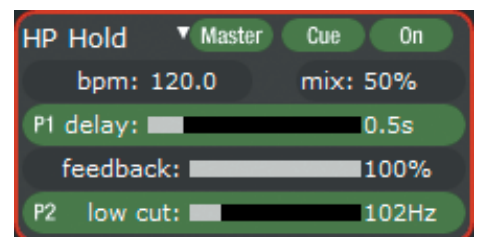
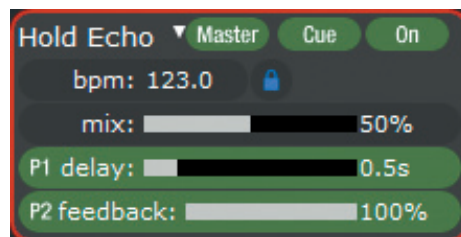
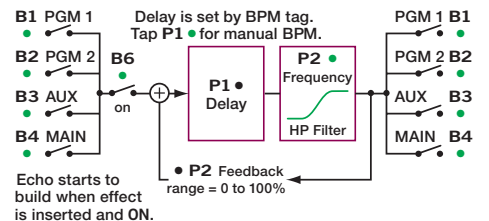

P1 DELAY / TAP BPM

Once you turn **P1**, the lock icon disappears, the Multiplier number turns white and **P1** becomes a Delay control. Delay has a range of 1ms to 2.9 seconds, and a track without a BPM tag will start at 500 ms. A slow turn gives 1ms adjustment resolution, while a fast turn increases the resolution to 200 ms per step. To get back to the original BPM after adjusting Delay, select a multiplier with **J1**, and the Multiplier number changes to green. A single Tap of **P1** resyncs the delay to the BPM.

J1 MULTIPLIER

Pressing **J1** toggles between normal transform operation (indicator off) and the BPM Multiplier (green indicator on). With the green indicator lit, **J1** adjusts the multiplier to 4, 2, 1, 3/4, 1/2, 1/4, 1/8, or 1/16. Multipliers that exceed the Delay memory will not function and are grayed-out in the software control panel. If BPM is set with tapping, the multiplier is set to 1. The multiplier is not reset when the BPM is set via the ID3 tag, so your subsequent tracks can stay at x4 if you wish. The active Multiplier is shown in green text when locked to a BPM.

P2 FEEDBACK

Feedback is the amount of delayed signal fed back to the delay input. Feedback minimum to maximum is 11/3 rotations of **P2**. The Delay clears after one circulation when Feedback is brought to 0%. The Delay clears immediately when uninserted, but changing the insert point does not clear the feedback loop. This is useful for adding PGM 2 Echo to the fading PGM 1 Echo. To clear the loop and start a fresh Echo immediately, rapid double-click on the insert point **B1**, **B2**, **B3** or **B4**.

J2 WET / DRY MIX

Pressing **J2** toggles between transform operation (indicator off) and Wet / Dry control (green indicator on). The hold echo default is 50% Wet / 50% Dry. **J2** has the same operation on all effects. SEE "J2 WET / DRY MIX" ON PAGE 44.

DESECRATOR CONTROL ASSIGNMENTS

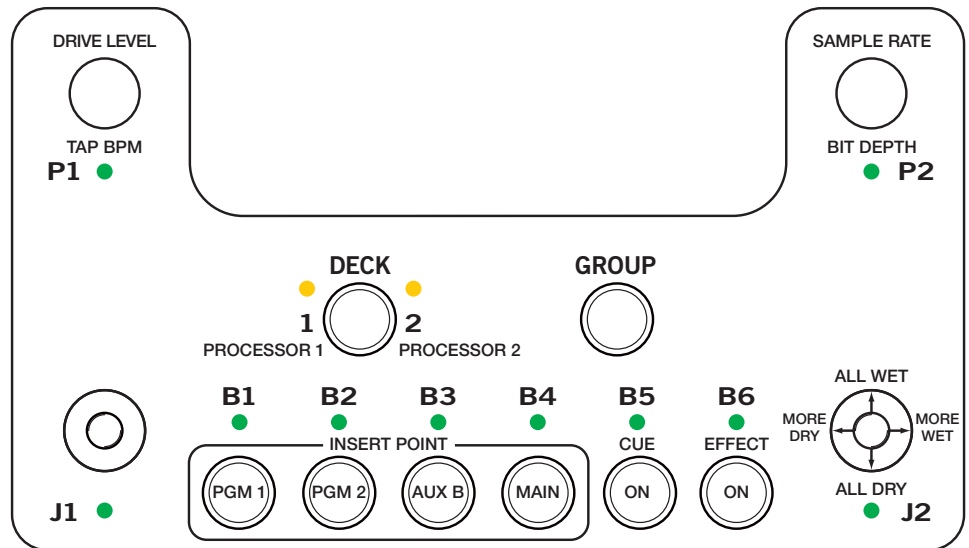

The Desecrator adds controlled distortion, from fine dust to rusty metal spikes, by allowing adjustment of bit-depth and sample rate without dithering or anti-aliasing. Clipping can be a fine shave, or enough for a wig! Signal flow and control is shown below.

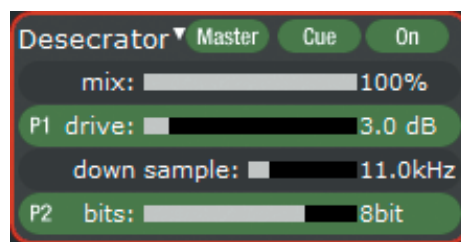
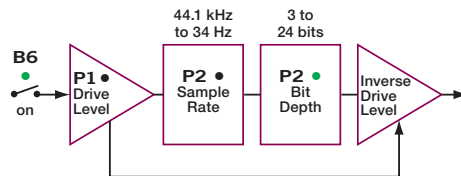

P1 DRIVE LEVEL

The only function of **P1** (indicator off) is Drive Level, adjusting from 0 dB to +24 dB in 32 uniform steps. To keep audio output level constant, inverse gain is applied after the bit-depth stage. A slight level reduction occurs when clipping. **P1** has no second function when using the Desecrator.

J1 has no function when using the Desecrator.

P2 SAMPLE RATE / BIT DEPTH

Sample Rate is the primary function of **P2** (indicator off) adjusting the sample rate from a clean 44.1 kHz to a dirty 34 Hz over 32 steps with 1/3-octave spacing.

Bit Depth is adjusted with the second function of **P2** (green indicator on) adjusts from a creamy 24 bits to a crunchy 3 bits in 22 steps. Increasing the **P1** Drive Level increases the spreadability when bits are reduced to a single digit.

J2 WET / DRY MIX

Pressing **J2** toggles between transform operation (indicator off) and Wet / Dry control (green indicator on). The desecrator default is 100% wet. **J2** has the same operation on all effects. SEE "J2 WET / DRY MIX" ON PAGE 44.

MAGNETIC FADER Q AND A

Q. WILL I DAMAGE THE FADERS IF I SPRAY THEM WITH BAD STUFF OR SPILL BAD THINGS IN THEM?

A. No. The faders in the TTM 57SL are designed with materials highly resistant to corrosion and most chemicals. There are no electrical contacts to clean or damage. While bad things may change the feel of the faders, bad things will not affect the sound. To clean faders that have had a bad thing put in them, follow the simple instructions to the right.

Q. CAN I INSTALL MAGNETIC FADERS IN ANY OTHER MIXER?

A. Sorry. The connectors may be similar, but the circuits are very different. Connecting the faders to anything other than the intended cable in the TTM 57SL could permanently damage them.

Q: CAN I INSTALL OTHER FADERS IN MY TTM 57SL?

A. No. The cable connections are specially designed for Rane magnetic faders.

Q. CAN I INSTALL A DIFFERENT MAGNETIC FADER IN MY MIXER OR SWAP THE POSITION OF MY FADERS?

A. No. In order to achieve the highest possible accuracy, each magnetic fader is factory calibrated for the location in which it was shipped. For information about replacement or calibration in the USA, contact Rane Customer Service. If you remove the faders for cleaning, make sure you mark them. This helps you to put them back in the same location

MAGNETIC FADER MAINTENANCE

There are no electrical contacts to clean!

The faders in the TTM 57SL are designed with materials highly resistant to corrosion and most chemicals. While the faders will handle millions of operations, they may become dirty over time. Bad things may be spilled into the faders, but in many instances the faders may not be damaged and the sound quality thus unaffected. Cleaning is only required to maintain the feel of the faders.

The faders are self-lubricating and with normal use, should not require additional lubrication. If you wish, you can use a light silicone lubricant rated for use with electrical parts. This will help maintain the feel. We highly recommend Caig DeoxIT FaderLube F100 spray lubricant.

Order DeoxIT® F100 from:

CAIG Laboratories, Inc.

12200 Thatcher Ct.
Poway, CA 92064
Phone 858-486-8388
Fax 858-486-8398
Web www.caig.com

Caution! Sugary liquids may damage the fader beyond repair!

Never use a heavy lubricant or grease.

Doing so may not damage the faders, but can affect the feel. If grease was used, it may be removed by following the cleaning instructions. Light lubrication is possible with the Lexan plate on. A couple of drops or a short spray will do it. Make sure the products you use are suitable for use with electrical parts that contain plastic.

MAGNETIC FADER RAIL CLEANING

- A. Move the carrier all the way to one side.
- B. Use a soft lint-free cloth to wipe off the rails.
- C. Add a drop of silicone lubricant (or quick spray from aerosol) to the center of each rail.
- D. Move the carrier back and forth to distribute lubricant.
- E. Do not bend the torsion spring or touch the sensors.

For more effective cleaning and lubrication, follow the directions below:

1. Required Tool: #1 Philips screwdriver.
2. Disconnect the power.
3. Remove knobs from controls covered by the Lexan faceplate.
4. Remove the four, 4-40 screws attaching the Lexan faceplate.
5. Remove the Lexan faceplate. See the picture and instructions below. The rails of the fader are now accessible for normal cleaning and lubrication.
6. Remove fader from mixer if more thorough cleaning is required.
7. NOTE: Do not disturb the position of the small sensors at each end of the Fader. If you do, make sure the parts are standing straight before reinstalling.

8. NOTE: In order to achieve the highest possible accuracy, each magnetic fader is factory calibrated for the location in which it was shipped. If you remove the faders for cleaning, make sure you mark them. This helps you to put them back in the correct location.
9. Remove the fader by removing the two #4 screws securing it. Then disconnect the ribbon cable.
10. Sugary liquids spilled into a fader may be removed by thoroughly rinsing the part in hot

water. Make sure the part is clean and dry before lubricating or reinstalling.

11. Removal of grease or other stubborn debris may require alcohol or contact cleaner. Make sure the part is clean and dry before lubricating or reinstalling.
12. To reassemble, reverse the disassembly procedure.
13. Problems? Contact Rane Corporation customer service at 425-355-6000 or email us at info@rane.com.

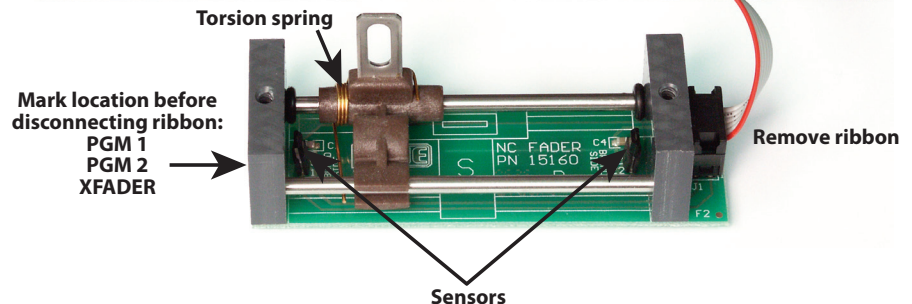
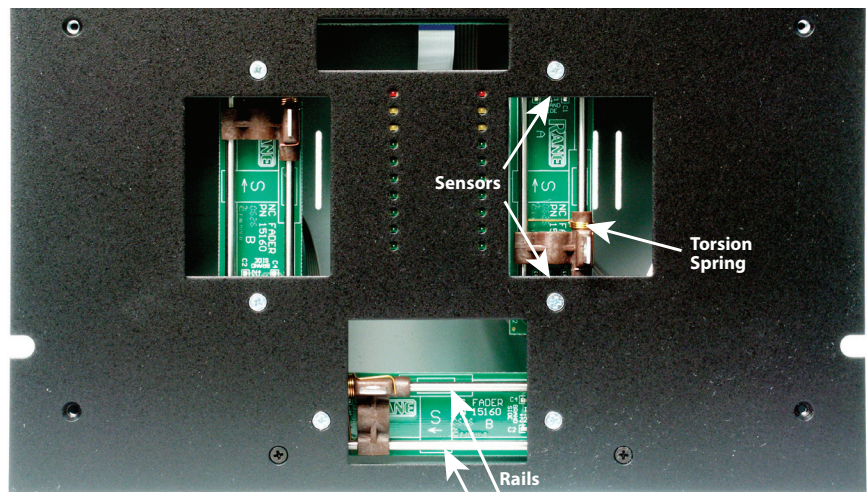

TROUBLESHOOTING AND FREQUENTLY ASKED QUESTIONS

THE AUDIO PLAYBACK IS DROPPING OUT / CLICKING / POPPING

Scratch Live is not getting a clear signal from the record, or your computer is not able to process the information quickly enough. Go to the Setup screen and check the scope views. When the record is playing, the circles should be round, and the value in the bottom right corner should be 100%. If this is not the case, you need to calibrate. **SEE “CALIBRATING SCRATCH LIVE” ON PAGE 12.**

Try increasing the USB audio buffer size if your computer is close to the minimum spec. **SEE “USB BUFFER SIZE (LATENCY)” ON PAGE 33.**

Clean your needles! This is the most common cause of audio drop-out. Because you are playing the same record over and over, the needles will get dirty more quickly than usual.

THE THRESHOLD GOES TO THE FAR RIGHT WHEN I CLICK THE ESTIMATE BUTTON

Make sure the needle is on the record and the record is stopped when you click Estimate. If the slider goes hard right and stays there, you most likely have an earthing problem with your turntables/mixer. If you cannot eliminate this problem, use REL mode over ABS mode.

SCRATCH LIVE MAKES A STRANGE DIGITAL NOISE, EVEN WHEN NO TRACK IS PLAYING

Scratch Live is interpreting background noise as record movement. Go to the Setup screen and move the threshold slider (located left of the Estimate button) to the right until the noise stops. **SEE “CALIBRATING SCRATCH LIVE” ON PAGE 12.**

THE TRACKS ARE PLAYING BACKWARDS!

The inputs (from the turntables or CD players) are the wrong way around. Try swapping red and white wires at one end.

I CAN'T GET THE SCOPE VIEW TO SHOW NICE CLEAN CIRCLES

Select phono as the audio input level in the setup screen if you are using vinyl. Check your needles to be sure they are clean. If the circles look fuzzy, try cleaning your control record. If the Scope View shows a line instead of a circle, Scratch Live is only receiving a signal from one channel. Check all your cables, and the connection between your cartridges and the tone arm. You can order replacement control records from your local distributor. In the USA, you may order these from the Rane Factory Store at rane.com.

THE FIRST TIME I PLAY A NEW TRACK, IT TAKES A WHILE TO LOAD

Scratch Live has to read the entire file and create a file index the first time it is loaded. This may take a few seconds for longer files. After the first load, it should load instantly. **SEE “PREPARING YOUR FILES” ON PAGE 14.**

I HAVE A PARTICULAR MP3 THAT WON'T PLAY / PLAYS BADLY / TAKES A LONG TIME TO LOAD / CRASHES THE PROGRAM. WHAT SHOULD I DO?

The file may be damaged, and may need to be deleted from your library. Please go to the forum at serato.com and notify the support team that you have a bad file. By reporting damaged or corrupt files, you will help the developers to improve Scratch Live's ability to play damaged MP3 files in the future.

I GET A LOUD SCREECHING SOUND LIKE A FAX MACHINE AND NO MUSIC, WHAT AM I DOING WRONG?

That is the sound of the control signal — make sure you are listening to inputs D1 and D2 when using Scratch Live.

SCRATCH LIVE FREAKS OUT WHEN I USE THE MASTER TEMPO (KEY CORRECTION) FUNCTION ON MY CD PLAYER

Scratch Live interprets the signal coming out of the CD player, and uses this information to control the play back of the files on your computer. Any

audio processing performed on the signal before it reaches the hardware interface, such as key correction, will scramble the signal making it illegible to Scratch Live. Key lock is available in Scratch Live. **SEE “KEY LOCK” ON PAGE 17.**

I WANT TO BACKUP MY LIBRARY AND CRATES OR MOVE THEM TO ANOTHER MACHINE, SO WHERE ARE THEY STORED?

Your database and crates are stored in the folder Home\Music_Serato_ on a Mac, and My Documents\My Music_Serato_ in Windows XP, and Libraries\Music_Serato_ in Windows 7. If your library contains tracks that are stored on a drive other than your boot drive, a folder called _Serato_ will be created in the root of that drive, and a separate database will be made in this folder. If it is a removable drive, the tracks will only appear in your library when the drive is connected. **SEE “SCRATCH LIVE BACKUP” ON PAGE 31.**

I HAVE PINK FILES WHICH DON'T PLAY

These are files which Scratch Live thinks are missing. You can use the Relocate Lost Files feature in the Offline player to re-associate these with their new location. To do this you can either: drag the file itself from Finder/Windows explorer onto the button to relocate an individual file, drag an entire folder onto this button, or press the button (this will search all connected drives for all the missing files in your library).

I HAVE CUE BURN AT THE BEGINNING OF MY CONTROL RECORD, DOES THAT MEAN I NEED TO REPLACE IT?

No, use the Track start offset function in the Setup screen to move the point at which tracks begin to a position further into the vinyl. **SEE “VINYL START OFFSET” ON PAGE 36.**

WHAT ARE THE BEST CARTRIDGES TO USE WITH SCRATCH LIVE?

We recommend the Ortofon | Serato S-120 cartridges for use with Scratch Live. These employ revolutionary new cantilever suspension, which delivers high output volume, unrivaled tracking ability and low record wear.

To keep up with the latest tips, visit the Official Scratch Live Forum online at serato.com.

CORRUPT FILE DESCRIPTIONS AND DIAGNOSES

Corrupt file: This MP3 contains invalid frames.	This MP3 contains frames which do not conform strictly to the official MP3 specification. Scratch Live can not be certain that this file will play back 100% accurately.
Corrupt file: This file contains corrupt frames that may result in audible glitches.	This file contains two or more contiguous corrupt frames. Since corrupt frames are replaced with silence, this could result in what might sound like an audio glitch.
Corrupt file: This file structure is incorrect.	This file has caused the QuickTime metadata manager to fail.
Corrupt file: This file has been split. You should check the beginning for audio glitches.	The first MPEG audio frame in this file refers to audio that should be present before it but is not. This is usually the result of incorrect MP3 editing. Since a corrupt frame is replaced with silence and most songs start with silence, the resulting silence might not be noticeable. All the same, listen to the beginning of the song, just to be sure.
Corrupt file: This MP3 contains frames with corrupt data.	Decoding of an MPEG audio frame failed. This means that the frame contained invalid data. As usual with corrupt frames, this frame will be played as silence.
Corrupt file: This MP3 lost synchronization between the frame index and the frames.	Scratch Live is reading an old overview of an MP3 that has been edited in a 3rd party editing program. Re-building the overviews for the affected files usually corrects this error.
Corrupt file: This MP3 is completely invalid and is not playable.	Self explanatory. Possible causes are disk bad sectors, file system corruption, wrong file types, wrong file extensions, etc
Corrupt file: This file contains invalid audio data.	Scratch Live encountered invalid data while looking for audio in this file. This message alerts you to the fact that the file you're trying to play contains corrupt data. This may, or may not, affect playback.
Corrupt file: This MP3 contains no valid frames.	No audio could be found in this file, which means it is completely unplayable as far as Scratch Live is concerned. Please make sure this really is an audio file.
Unsupported file: This MP3 contains multiple layers.	While scanning, Scratch Live found frames belonging to multiple MPEG layers. Scratch Live does not support MP3s that contain frames from multiple layers – some frames may be output as silence.
Unsupported file: This file is more than 2GB in size.	Self explanatory. At the moment, Scratch Live does not support files that are 2GB in size (or larger).
Unsupported file: This file has data blocks greater than 2GB in size.	This file contains chunks of data that are larger than 2GB. Scratch Live does not support files that are more than 2GB in size.
Corrupt file: This WAV contains no valid chunks.	This WAV file contains no recognizable WAV data. It is quite possible that this might not be a WAV file.
Unsupported file: This file's data is not in PCM format.	WAV files can contain data in several formats. Scratch Live only supports WAV files that contain data in the PCM format.
Unsupported file: This file has a sampling rate greater than 96 kHz.	Scratch Live does not support sampling rates greater than 96 kHz. If you see this message, the simplest approach is to re-sample the audio at 96 kHz and re-save the file.
Unsupported file: This file uses more than 24 bits per sample	Scratch Live supports a maximum of 24 bits per sample of audio data.
Corrupt file: This WAV is incomplete.	Scratch Live expected more data in the file, but found none. This could be because the file was incorrectly truncated or because the data in the file is corrupt, causing Scratch Live to incorrectly estimate the amount of data present in the file.
Corrupt file: This file contains corrupt blocks.	This file contains blocks of data that report their size to be zero. This message was inserted to identify files that might cause lockups on previous versions of Scratch Live.
Corrupt file: This song contains no audio data.	Scratch Live could not find any audio in this file. Please check to make sure this file contains audio in a format that Scratch Live supports.
Corrupt file: This song contains invalid samples.	This file contains samples of audio that are too small to represent accurately and will therefore be truncated to zero. This should not result in any audible audio artifacts, but could cause audio dropouts on earlier versions of Scratch Live.

SCOPE READING AND FIXES

Most of the problems that occur with Scratch Live can be attributed to it not getting a good reading of the control signal from your records or CDs. These examples show what the scopes on the setup screen can look like to help solve possible problems. Some problems cause similar looking scopes, e.g., if your scopes look like the Dusty Needle one, the cause could be a damaged needle.

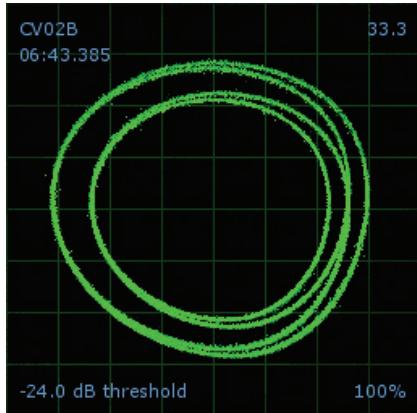

GOOD SIGNAL - Clean signal with 100% tracking.

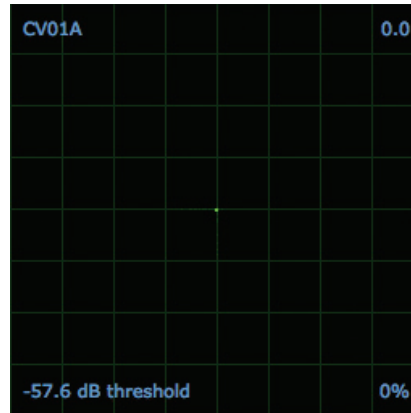

NO SIGNAL - Scratch Live is not receiving any control signal - check your connections.

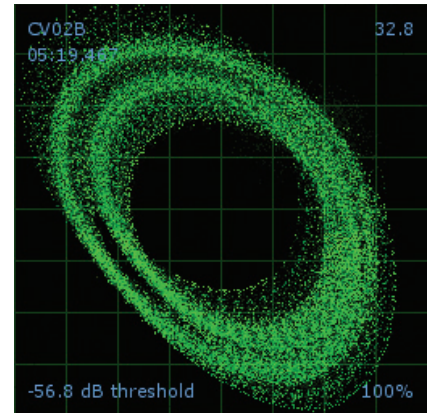

BAD TURNTABLE VIBRATION - Bass is reaching the stylus. Try to isolate the turntable from the speakers.

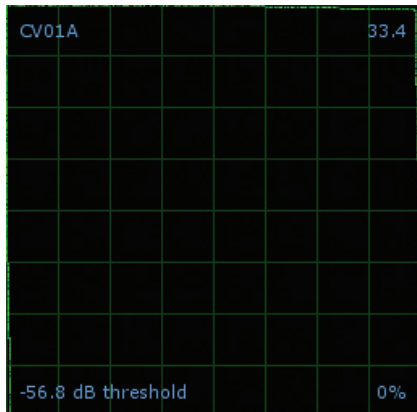

CD PLAYER INTO PHONO INPUT - The TTM 57SL is set to receive a phono level input. Switch to the LINE setting on the TTM 57SL.

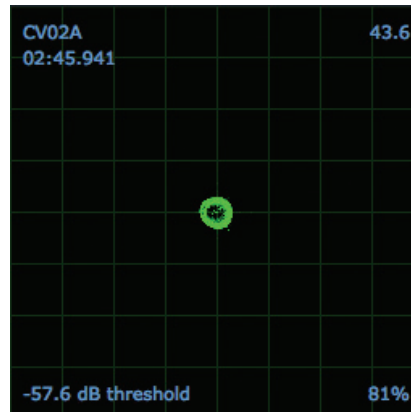

PHONO INTO LINE INPUT - The TTM 57SL is set to receive line level input. Switch to the PHONO setting on the TTM 57SL.

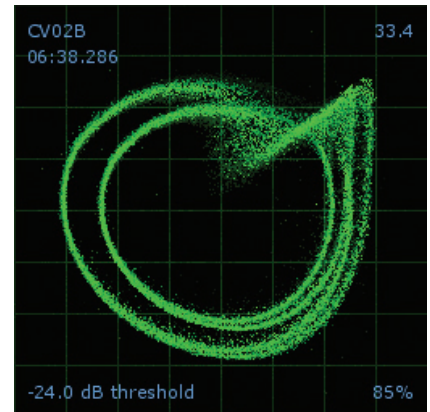

DUSTY NEEDLE - Dust is preventing the stylus from tracking the groove correctly. Clean your needle and the control vinyl.

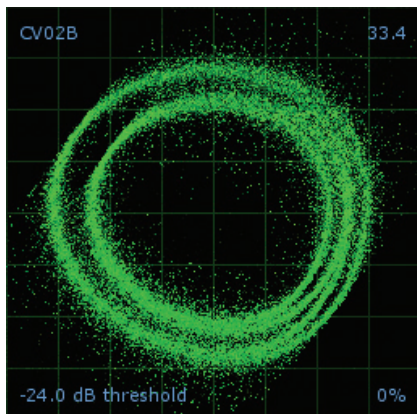

UNEARTHED - Very susceptible to interference. Attach the turntable's ground wire to the TTM 57SL.

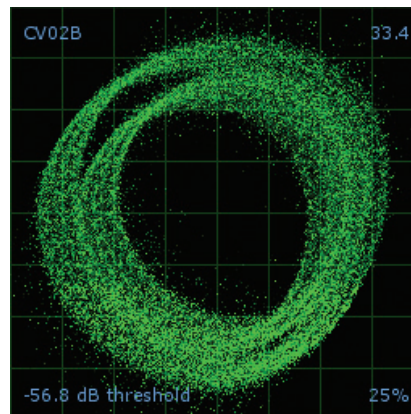

USING PIGGYBACK CABLES - Picking up huge amounts of noise, barely tracking. Connect your turntables directly to the TTM 57SL.

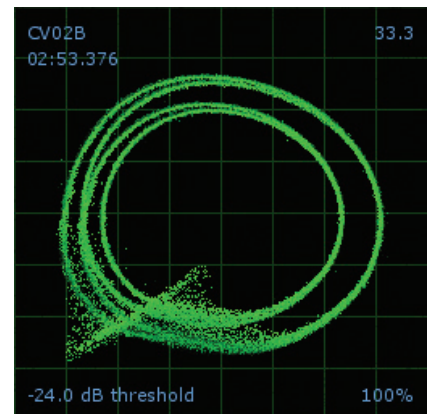

DAMAGED NEEDLE - Try re-seating, cleaning or replacing your stylus.

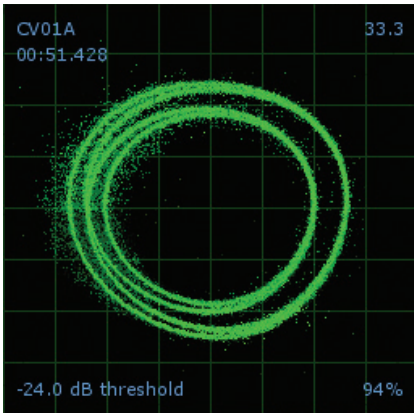

RECORD BURN - This section of the control vinyl has been worn. Swap sides or use the track start offset.

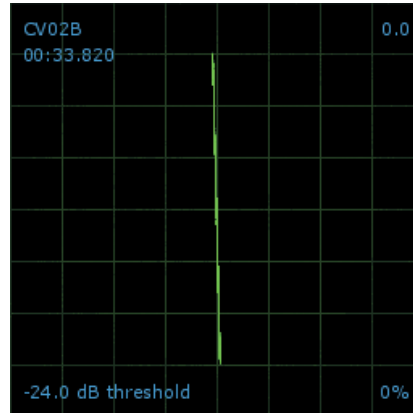

LEFT CHANNEL MISSING - The signal from the needle is not reaching the TTM 57SL. Check the cable and cartridge connections.

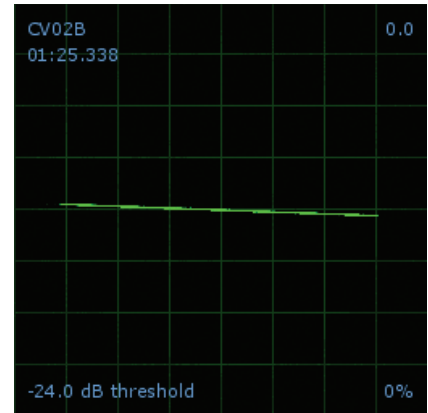

RIGHT CHANNEL MISSING - The signal from the needle is not reaching the TTM 57SL. Check the cable and cartridge connections.

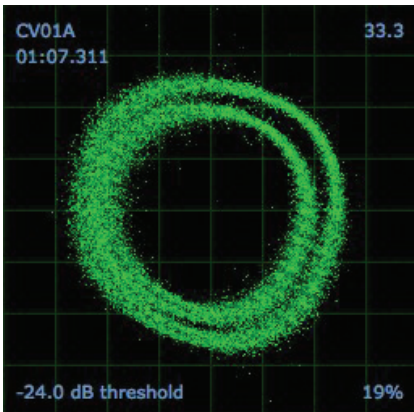

BAD RECORD BURN - Your record is very badly worn and Scratch Live is unable to track correctly. Swap sides or get new vinyl ASAP.

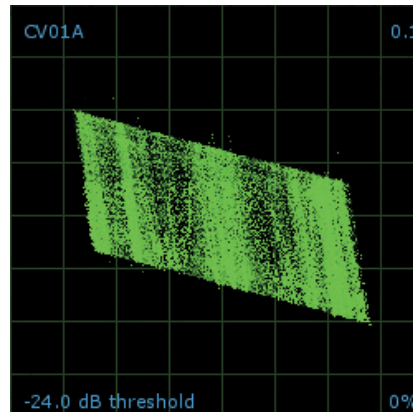

LEFT CHANNEL IS NOISE - Left signal has been lost with a noisy loose connection.

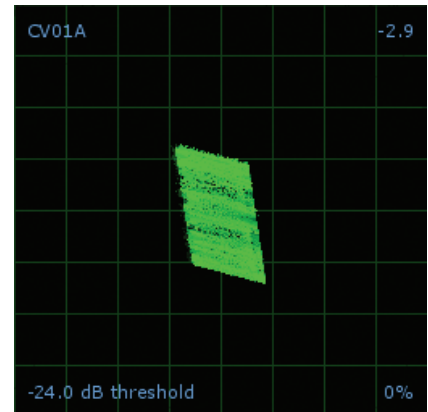

RIGHT CHANNEL IS NOISE - Right signal has been lost with a noisy loose connection.

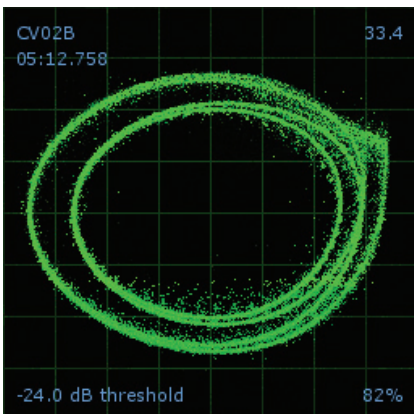

TONEARM IS SLIGHTLY TOO LIGHT - Susceptible to dust and vibration. Adjust the tonearm.

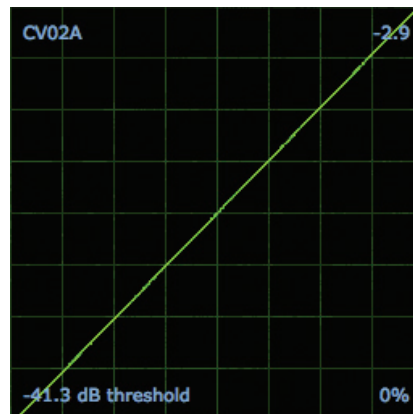

SIGNALS ARE SUMMING TO MONO - The left and right signals have been combined into one somewhere in your signal chain.

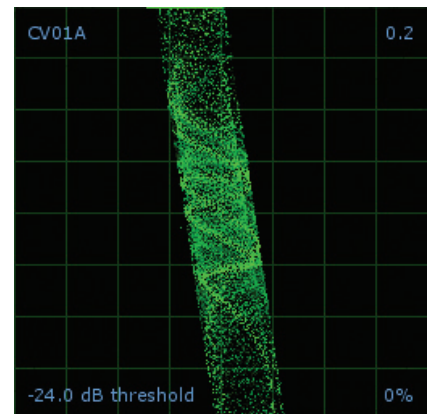

RIGHT CHANNEL IS INTERFERENCE - Right signal has been lost with a noisy loose connection and left channel crosstalk.

KEYBOARD SHORTCUTS

These actions can be accessed directly from the computer keyboard.

NOTE: Playback, cue and speed controls use Shift or Caps Lock, you can turn this off in the setup screen. SEE "PLAYBACK KEYS USE SHIFT" ON PAGE 34.

KEY	ACTION
ctrl - L	Locate the current track. This will highlight the track you most recently loaded. Pressing ctrl - L again will alternate between the tracks recently loaded on both decks.
ctrl - R	Reveal - the highlighted song is opened in a file browser.
ctrl - F	Find - moves the cursor to the search box.
ctrl - A	Select all.
ctrl - C	Copy text in edit mode.
ctrl - E	Edit text.
ctrl - V	Paste text in edit mode.
ctrl - X	Cut text in edit mode.
ctrl - Z	Undo last track load.
shift - ctrl - ↑ shift - ctrl - ↓	Move focus up / down through the library or crates. Note that if you have a song highlighted in the song view, and use <i>shift - ctrl - ↑ ↓</i> you will move up or down through the library or crates. When you release the shift or ctrl key, the focus will go back to the song view so that you can move up and down through songs using ↑ ↓.
ctrl - P	Add tracks to the prepare window.
ctrl - N	Start a new mic recording.
ctrl - O	Open the track in your default MP3/WAV/OGG/AIF player.
- or +	Zoom the main waveform display.
ctrl - or +	Zoom the library text size.
tab	Alternate focus between crates or songs.
ctrl - del and ctrl - backspace	Remove track from library., remove track from crate, delete crate (does not delete the file).
alt - del and alt - backspace	Remove track from crate and from library.
ctrl - shift - del and ctrl - shift - backspace	Delete the file from your library <i>and</i> send to the recycle bin. (Note to iTunes users: files in your iTunes library cannot be deleted this way).
ctrl - shift - /	Toggle the input reverse switch
esc	Clear search string if searching, or exit Scratch Live.

SAMPLE PLAYER	slot 1	slot 2	slot 3	slot 4	slot 5	slot 6
Load to sample slot	ctrl - alt - Z	ctrl - alt - X	ctrl - alt - C	ctrl - alt - V	ctrl - alt - B	ctrl - alt - N
Play sample slot	Z	X	C	V	B	N

LEFT DECK	ACTION	RIGHT DECK
ctrl - ← or shift - ←	Load the highlighted song to a deck.	ctrl - → or shift - →
ctrl - shift - →	Load the track currently on one deck onto the other deck as well.	ctrl - shift - ←
ctrl - , (comma)	Place a cue point.	ctrl - . (period)
ctrl - 1, 2, 3, 4, 5	Place a cue point in a slot.	ctrl - 6, 7, 8, 9, 0
ctrl - , (comma)	Place a cue point.	ctrl - . (period)
1, 2, 3, 4, 5	Jump to cue points in track. (REL and INT modes)	6, 7, 8, 9, 0
F1	Switch deck to ABS mode.	F6
F2	Switch deck to REL mode.	F7
F3	Switch deck to INT mode.	F8
F5	Key lock on / off.	F10
Q	Play / pause reverse.	A
W	Play / pause forward.	S
E	Pitch down.	D
R	Pitch up.	F
T	Bend down. (REL and INT modes)	G
Y	Bend up. (REL and INT modes)	H
U	Censor. (REL and INT modes)	J
I	Go to temporary cue point. (REL and INT modes)	K
O	Set / adjust loop in-point.	L
P	Set / adjust loop out-point.	;
[Loop on / off.	'
ctrl - [Jump to selected loop.	ctrl - '
alt - Q	Load previous track.	alt - A
alt - W	Load next track.	alt - S
alt - 1, 2, 3, 4, 5	Auto loop on / off.	alt - 6, 7, 8, 9, 0
ctrl - alt - 1, 2, 3, 4, 5	Loop roll.	ctrl - alt - 6, 7, 8, 9, 0
alt - E	Rewind. (REL and INT modes)	alt - D
alt - R	Fast forward. (REL and INT modes)	alt - F
alt - O	Previous loop.	alt - P
alt - L	Next loop.	alt - ;
alt - space bar	Activate the tempo tapper.	alt - space bar (x2)
ctrl - I	Set temporary cue point. (REL and INT modes)	ctrl - K

APPENDIX

FOOTSWITCH DIAGRAM

Rane does not manufacture or distribute the optional foot switch. The foot switch needs to be a passive pull-down device capable of grounding the TIP, RING or TIP and RING to get the three possible states. Good choices are the DigiTech FS300 or GNXFC. To the right is a basic diagram of a 3-switch foot switch. Three buttons gives the most flexibility, but you can also use one or two button footswitches. **TO CONFIGURE SCRATCH LIVE TO WORK WITH 1, 2 OR 3 BUTTON FOOTSWITCHES, SEE "FOOT SWITCH TYPE" ON PAGE 34.**

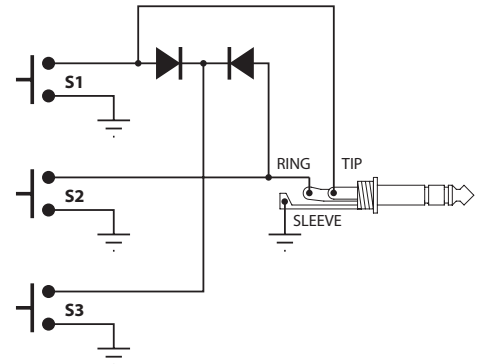

ANALOG DIAGRAM

Simplified block diagram of the analog inputs around the DSP. Only one channel is shown.

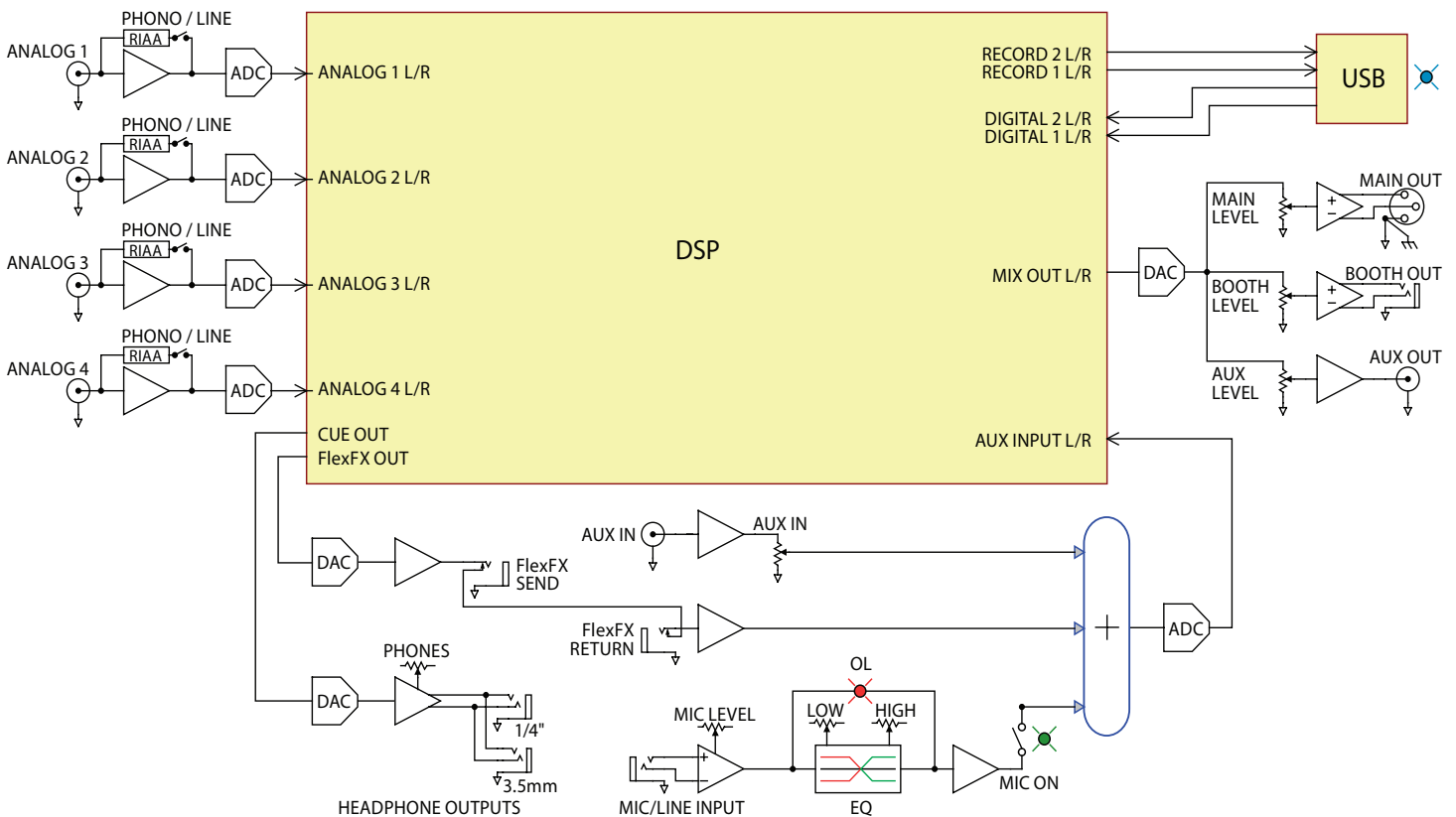

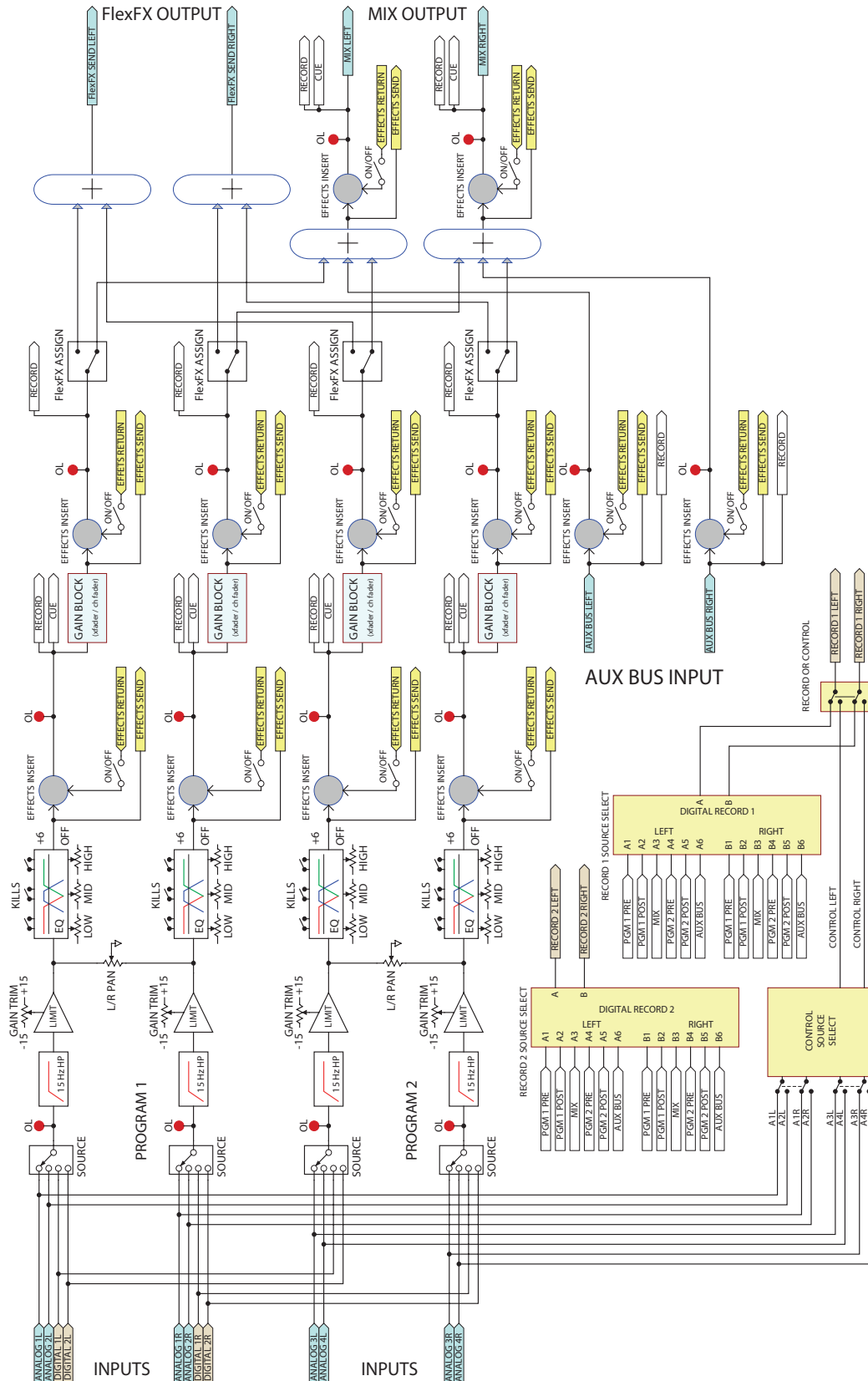
DSP PROCESSING BLOCK DIAGRAM

DECLARATION OF CONFORMITY

APPLICATION OF COUNCIL DIRECTIVE:

2006/95/EC
 2004/108/EC
 2002/96/EC
 2002/95/EC

STANDARD(S) TO WHICH CONFORMITY IS DECLARED:

EN60065:2002/A1:2006
 EN55103-1:1996
 EN55103-2:1996
 ENVIRONMENT E2
 SERIAL NUMBERS 700000-900000
 CE MARK FIRST AFFIXED IN: 2006

MANUFACTURER:

Rane Corporation
 10802 47th Avenue West
 Mukilteo WA 98275-5000 USA

This equipment has been tested and found to be in compliance with all applicable standards and regulations applying to the EU's Low Voltage (LV) directive 2006/95/EC, and the Electromagnetic Compatibility (EMC) directive, 2004/108/EC. In order for the customer to maintain compliance with this regulation, high quality shielded cable must be used for interconnection to other equipment. Modification of the equipment, other than that expressly outlined by the manufacturer, is not allowed under this directive. The user of this equipment shall accept full responsibility for compliance with the LV directive and the EMC directive in the event that the equipment is modified without written consent of the manufacturer.

TYPE OF EQUIPMENT: Professional Audio Signal Processing

BRAND: Rane

MODEL: TTM 57SL

Immunity Results: THD+N re: 12 dBu, 400 Hz sine, BW 20 Hz - 20 kHz, Baseline: -70 dB

Test Description	Measurement	Conditions
RF Electromagnetic Fields Immunity		
80 MHz -1000 MHz, 1 kHz AM, 80% depth, 3V/m	-66 dB	260 MHz
	-53 dB	400 MHz - 500 MHz
Conducted RF Disturbances Immunity		
150 kHz - 80 MHz, 1 kHz AM, 80% depth, 3V rms	-70 dB	Power Lines
	-70 dB	Signal and Control Lines
Magnetic Fields Immunity		
50Hz - 10kHz, 4.0 - 0.4 A/m	-70 dB	50 Hz - 10 kHz

I, the undersigned, hereby declare that the equipment specified above conforms to the Directive(s) and Standard(s) shown above.



 (Signature)

Roy G. Gill

 (Full Name)

Compliance Engineer

 (Position)

May 17, 2006

 (Date)

Mukilteo WA USA

 (Place)

FACTORY AUTHORIZED SERVICE

Your unit may someday need to be serviced by the Rane Factory if you live in the USA. International customers should contact your dealer or distributor for service. You must call the Rane factory before shipping. Please do not return your unit to Rane without prior authorization.

Rane Corporation

To obtain service or a Return Authorization in the USA, please phone 425-355-6000
or Fax 425-347-7757

LIMITED U.S.A. WARRANTY

RANE CORPORATION WARRANTS ALL RANE PRODUCTS (EXCEPT THOSE ITEMS CLASSIFIED AS WEAR PARTS, AND LISTED AT THE BEGINNING OF EACH OPERATORS MANUAL) PURCHASED IN THE U.S. AGAINST DEFECTS IN MATERIAL OR WORKMANSHIP FOR A PERIOD OF TWO (2) YEARS. WEAR PARTS ARE LIMITED TO A PERIOD OF NINETY (90) DAYS FROM THE INITIAL DATE OF RETAIL PURCHASE FROM AN AUTHORIZED RANE DEALER—WEAR PARTS REQUIRE PROOF OF PURCHASE DATE. This limited warranty extends to all purchasers or owners of the product during the warranty period beginning with the original retail purchase. Rane Corporation does not, however, warrant its products against any and all defects: 1) arising out of material or workmanship not provided or furnished by Rane, or 2) resulting from abnormal use of the product or use in violation of instructions, or 3) in products repaired or serviced by other than the Rane Factory, or 4) in products with removed or defaced serial numbers, or 5) in components or parts or products expressly warranted by another manufacturer. Rane agrees to supply all parts and labor to repair or replace defects covered by this limited warranty with parts or products of original or improved design, at its option in each respect, if the defective product is shipped prior to the end of the warranty period to the Rane Factory in the original packaging or a replacement supplied by Rane, with all transportation costs and full insurance paid each way by the purchaser or owner.

LIMITED WARRANTY OUTSIDE THE U.S.A.

RANE PRODUCTS ARE WARRANTED ONLY IN THE COUNTRY WHERE PURCHASED, THROUGH THE AUTHORIZED RANE DISTRIBUTOR IN THAT COUNTRY, AGAINST DEFECTS IN MATERIAL OR WORKMANSHIP, THE SPECIFIC PERIOD OF THIS LIMITED WARRANTY SHALL BE THAT WHICH IS DESCRIBED TO THE ORIGINAL RETAIL PURCHASER BY THE AUTHORIZED RANE DEALER OR DISTRIBUTOR AT THE TIME OF PURCHASE. Rane Corporation does not, however, warrant its products against any and all defects: 1) arising out of materials or workmanship not provided or furnished by Rane, or 2) resulting from abnormal use of the product or use in violation of instructions, or 3) in products repaired or serviced by other than authorized Rane repair facilities, or 4) in products with removed or defaced serial numbers, or 5) in components or parts or products expressly warranted by another manufacturer. Rane agrees, through the applicable authorized distributor, to repair or replace defects covered by this limited warranty with parts or products of original or improved design, at its option in each respect, if the defective product is shipped prior to the end of the warranty period to the designated authorized Rane warranty repair facility in the country where purchased, or to the Rane factory in the U.S., in the original packaging or a replacement supplied by Rane, with all transportation costs and full insurance paid each way by the purchaser or owner.

ALL REMEDIES AND THE MEASURE OF DAMAGES ARE LIMITED TO THE ABOVE SERVICES, IT IS POSSIBLE THAT ECONOMIC LOSS OR INJURY TO PERSON OR PROPERTY MAY RESULT FROM THE FAILURE OF THE PRODUCT; HOWEVER, EVEN IF RANE HAS BEEN ADVISED OF THIS POSSIBILITY, THIS LIMITED WARRANTY DOES NOT COVER ANY SUCH CONSEQUENTIAL OR INCIDENTAL DAMAGES. SOME STATES OR COUNTRIES DO NOT ALLOW THE LIMITATIONS OR EXCLUSION OF INCIDENTAL OR CONSEQUENTIAL DAMAGES, SO THE ABOVE LIMITATION MAY NOT APPLY TO YOU.

ANY AND ALL WARRANTIES, EXPRESS OR IMPLIED, ARISING BY LAW, COURSE OF DEALING, COURSE OF PERFORMANCE, USAGE OF TRADE, OR OTHERWISE, INCLUDING BUT NOT LIMITED TO IMPLIED WARRANTIES OF MERCHANTABILITY AND FITNESS FOR A PARTICULAR PURPOSE, ARE LIMITED TO A PERIOD OF TWO (2) YEARS FROM EITHER THE DATE OF ORIGINAL RETAIL PURCHASE OR, IN THE EVENT NO PROOF OF PURCHASE DATE IS AVAILABLE, THE DATE OF MANUFACTURE, SOME STATES OR COUNTRIES DO NOT ALLOW LIMITATIONS ON HOW LONG AN IMPLIED WARRANTY LASTS, SO THE ABOVE LIMITATIONS MAY NOT APPLY TO YOU. THIS LIMITED WARRANTY GIVES YOU SPECIFIC LEGAL RIGHTS, AND YOU MAY ALSO HAVE OTHER RIGHTS WHICH VARY FROM STATE TO STATE, COUNTRY TO COUNTRY.

WARRANTY PROCEDURE - VALID IN U.S.A. ONLY

NOTICE! You must complete and return the warranty card or register your product online to extend the Warranty from 2 years to 3 years!

TO VALIDATE YOUR EXTENDED WARRANTY: Use the postcard that came in the box with your unit, or go to www.rane.com and click on **New Product Registration**. Fill out the warranty completely, being sure to include the model and serial number of the unit since this is how warranties are tracked. If your Rane product was purchased in the U.S.A., mail the completed card or register online with to Rane Corporation within 10 days from the date of purchase. **If you purchased the product outside the U.S.A. you must file your warranty registration with the Rane Distributor in that country.** It is advised that you keep your bill of sale as proof of purchase, should any difficulties arise concerning the registration of the warranty card. **NOTICE: IT IS NOT NECESSARY TO REGISTER IN ORDER TO RECEIVE RANE CORPORATION'S STANDARD TWO YEAR LIMITED WARRANTY.**

WARRANTY REGISTRATION is made and tracked by MODEL AND SERIAL NUMBERS ONLY, not by the purchaser's or owner's name. Therefore any warranty correspondence or inquires **MUST** include the model and serial number of the product in question. Be sure to fill in the model and serial number in the space provided below and keep this in a safe place for future reference.

WARRANTY SERVICE MUST BE PERFORMED ONLY BY AN AUTHORIZED RANE SERVICE FACILITY LOCATED IN THE COUNTRY WHERE THE UNIT WAS PURCHASED, OR (if product was purchased in the U.S.) AT THE RANE FACTORY IN THE U.S.. If the product is being sent to Rane for repair, please call the factory for a Return Authorization number. We recommend advance notice be given to the repair facility to avoid possible needless shipment in case the problem can be solved over the phone. **UNAUTHORIZED SERVICE PERFORMED ON ANY RANE PRODUCT WILL VOID ITS EXISTING FACTORY WARRANTY.**

FACTORY SERVICE: If you wish your Rane product to be serviced at the factory, it must be shipped FULLY INSURED, IN THE ORIGINAL PACKING OR EQUIVALENT. This warranty will NOT cover repairs on products damaged through improper packaging. If possible, avoid sending products through the mail. Be sure to include in the package:

1. Complete return street shipping address (P.O. Box numbers are NOT acceptable).
2. A detailed description of any problems experienced, including the make and model numbers of any other system equipment.
3. Remote power supply, if applicable.

Repaired products purchased in the U.S. will be returned prepaid freight via the same method they were sent to Rane. Products purchased in the U.S., but sent to the factory from outside the U.S. **MUST** include return freight funds, and the sender is fully responsible for all customs procedures, duties, tariffs and deposits.

IN ORDER TO QUALIFY FOR RANE'S ONE YEAR EXTENDED WARRANTY (FOR A TOTAL OF 3 YEARS PARTS AND LABOR), THE WARRANTY MUST BE COMPLETELY FILLED OUT AND SENT TO US IMMEDIATELY. VALID IN USA ONLY.

WE RECOMMEND YOU WRITE YOUR SERIAL NUMBER HERE IN YOUR OWNERS MANUAL AND ON YOUR SALES RECEIPT FOR YOUR RECORDS.

SERIAL NUMBER: _____ **PURCHASE DATE:** _____

